

P/N: 87501-0101

Copyright

© 2020, FLIR Systems, Inc.

All rights reserved worldwide. Names and marks appearing herein are either registered trademarks or trademarks of FLIR Systems and/or its subsidiaries. All other trademarks, trade names or company names referenced herein are used for identification only and are the property of their respective owners.

Document identity

Publ. No.: 87501-0101

Commit: 68553

Language:

Modified: 2020-07-07

Formatted: 2020-07-07

Website

<http://www.flir.com>

Customer support

<http://support.flir.com>

Disclaimer

Specifications subject to change without further notice. Camera models and accessories subject to regional market considerations. License procedures may apply. Products described herein may be subject to US Export Regulations. Please refer to exportquestions@flir.com with any questions.



General description	
<p>The FLIR TG165-X lets you both see and evaluate the hot and cold spots that can indicate serious issues. Ideal for commercial electrical, facility maintenance applications, the FLIR TG165-X reduces diagnostic time while simplifying repair and maintenance reporting. FLIR MSX enhancement improves image clarity by embossing visual scene details on full thermal images, providing added context to help you accurately target potential faults and troubleshoot repairs. Record images to monitor maintenance history and reassure your customer that problems have been resolved.</p>	
<p>Key features:</p> <ul style="list-style-type: none"> • See beyond the limitations of single-spot IR thermometers with a 80 × 60 (4,800 pixel) true thermal imager. • FLIR patented MSX enhancement adds sharp visual detail to thermal images, making it easier to diagnose problems. • Measure a wide range of temperatures, from -25°C to 300°C (-13°F to 572°F). • Multipoint Laser pointer provides a circle to clearly show the area you are measuring. • Rugged and reliable with an IP54 enclosure that protects the camera from dirt, dust, and oil. 	
Imaging and optical data	
IR resolution	80 × 60 pixels
Thermal sensitivity/NETD	< 70 mK
Field of view (FOV)	51° × 66°
Minimum focus distance	0.3 m (0.98 ft.)
Distance to spot ratio	24:1
Pseudo dual range	No
Image frequency	8.7 Hz
Focus	Fixed
Detector data	
Focal plane array/spectral range	Uncooled microbolometer/7.5–14 μm
Detector pitch	17 μm
Image presentation	
Display resolution	320 × 240 pixels
Surface brightness (cd/m ²)	400
Screen size	2.4 in. portrait
Viewing angle	80°

P/N: 87501-0101

© 2020, FLIR Systems, Inc.

#87501-0101; r. 68553;

Image presentation	
Color depth (bits)	24
Aspect ratio	4:3
Display technology	TFT
Cover glass material	Optical grade silicon
Image adjustment	Automatic
Image modes	<ul style="list-style-type: none"> MSX (Multi Spectral Dynamic Imaging) Visual with temperature reading
Gallery	Yes
Measurement	
Object temperature range	-25 to 300°C (-13 to 572°F)
Object temperature range and accuracy (ambient temp. 15 to 35°C (59 to 95°F))	-25 to 0°C (-13 to 32°F), acc. ±3°C (±7°F)
	0 to 50°C (32 to 122°F), acc. ±2.5°C (±5°F)
	50 to 100°C (122 to 212°F), acc. ±1.5°C (±3°F)
	100 to 300°C (212 to 572°F), acc. ±2.5%
IR temperature resolution	0.1°C (0.2°F)
Repeatability of reading	±1% of reading or ±1°C (2°F), whichever is greater
Response time	150 ms
IR thermometer measurement	Continuous scanning
Minimum measurement distance	0.26 m (0.85 ft.)
Measurement analysis	
Spotmeter	Center spot on/off
Color palettes	<ul style="list-style-type: none"> Iron Rainbow Whitehot Blackhot Arctic Lava
Set-up	
Set-up commands	<ul style="list-style-type: none"> Local adaptation of units, language, date, and time formats Screen brightness (high, medium, low) Gallery, deletion of images
Emissivity correction	Yes: 4 pre-set levels with custom adjustment of 0.1–0.99
Languages	Czech, Danish, Dutch, English, Finnish, French, German, Greek, Hungarian, Italian, Japanese, Korean, Norwegian, Polish, Portuguese, Russian, simplified Chinese, Spanish, Swedish, traditional Chinese, Turkish
Service functions	
Camera software update	Download from http://support.flir.com
Storage of images	
Storage media	eMMC 4GB
Image storage capacity	50,000 images
Image file format	JPEG with spot temp in meta tag



FLIR TG165-X

P/N: 87501-0101

© 2020, FLIR Systems, Inc.

#87501-0101; r. 68553;

Digital camera	
Resolution	2 MP (1600 × 1200 pixels)
Focus	Fixed
Field of view	71° × 56°, adapts to the IR lens
Flashlight	
Flashlight	Bright LED on/off
LED CCT	6500°K
LED CRI	70
Beam angle	±20°
Rated power	0.5 W
Light output (Lumens)	100
Laser pointer	
Laser pointer	Indicating the size of the measurement area
Laser	Class 1
Data communication interfaces	
Interfaces	USB 2.0
USB	USB Type-C: data transfer/power
USB standard	USB 2.0 High Speed
Power system	
Battery type	Rechargeable Li ion battery
Battery voltage	3.7 V
Battery capacity	3000 mAh
Battery operating time	<ul style="list-style-type: none"> • 5 hours of scanning (LCM medium brightness) • 4.5 hours with laser on (LCM medium brightness)
Battery charge life	30 days minimum
Charging system	Battery is charged inside the camera
Charging time	4 hours to 90%, 6 hours to 100%
Charging temperature	0 to 45°C (32 to 113°F)
Power management	Adjustable: off, 5 minutes, 15 minutes, 30 minutes
Environmental data	
Operating temperature range	-10 to 45°C (14 to 113°F)
Storage temperature range	-30 to 55°C (-22 to 131°F)
Humidity (operating and storage)	0–90% relative humidity (RH) (0 to 37°C (32 to 98.6°F)) 0–65% RH (37 to 45°C (98.6 to 113°F)) 0–45% RH (45 to 55°C (113 to 131°F))
EMC	<ul style="list-style-type: none"> • EN 61000-6-3 • EN 61000-6-2 • FCC 47 CFR Part 15 Class B
Magnetic fields	EN 61000-4-8 class 3



FLIR TG165-X

P/N: 87501-0101

© 2020, FLIR Systems, Inc.

#87501-0101; r. 68553;

Environmental data	
Radio spectrum	<ul style="list-style-type: none">• ETSI EN 300 328• FCC Part 15.249• RSS-247 Issue 2• EN 301 489-1:2011• EN 301 489-17:2009
Encapsulation	IP 54 (IEC60529)
Shock	25 g (IEC 60068-2-27)
Vibration	2 g (IEC 60068-2-6)
Drop	Designed for 2 m (6.56 ft.)
Safety	CE/CB/EN61010/UL
Environmental safety	<ul style="list-style-type: none">• REACH Regulation EC 1907/2006• RoHS2 Directive 2011/65/EC• WEEE Directive 2012/19/EC• JIS C 6802:2011 laser directive (ongoing)• IEC 60825-1 class I laser directive• FDA laser
Humidity requirement	<ul style="list-style-type: none">• IEC 60068-2-30 / 24h 95% Relative Humidity +25 - +70°C / 2 Cycles (Storage)• IEC 60068-2-30 / 24h 95% Relative Humidity +25 - +40°C / 2 Cycles (Operating)
Physical data	
Weight (including battery)	0.394 kg (13.9 oz.)
Size (L x W x H)	210 x 64 x 81 mm (8.3 x 2.5 x 3.2 in.)
Tripod mounting	UNC ¼"-20
Warranty and service	
Warranty	http://www.flir.com/warranty/
Shipping information	
Packaging, type	Cardboard box
Packaging, contents	<ul style="list-style-type: none">• TG165-X• Printed documentation• Wrist strap lanyard• USB cable• Pouch
Packaging, weight	0.942 kg (2.08 lb.)
Packaging, size	284 x 151 x 105 mm (11.2 x 5.95 x 4.12 in.)
EAN-13	7332558023822
UPC-12	845188019570
Country of origin	Taiwan

Supplies & accessories:

- T130976ACC; Retractable lanyard, 7 N (24 oz)

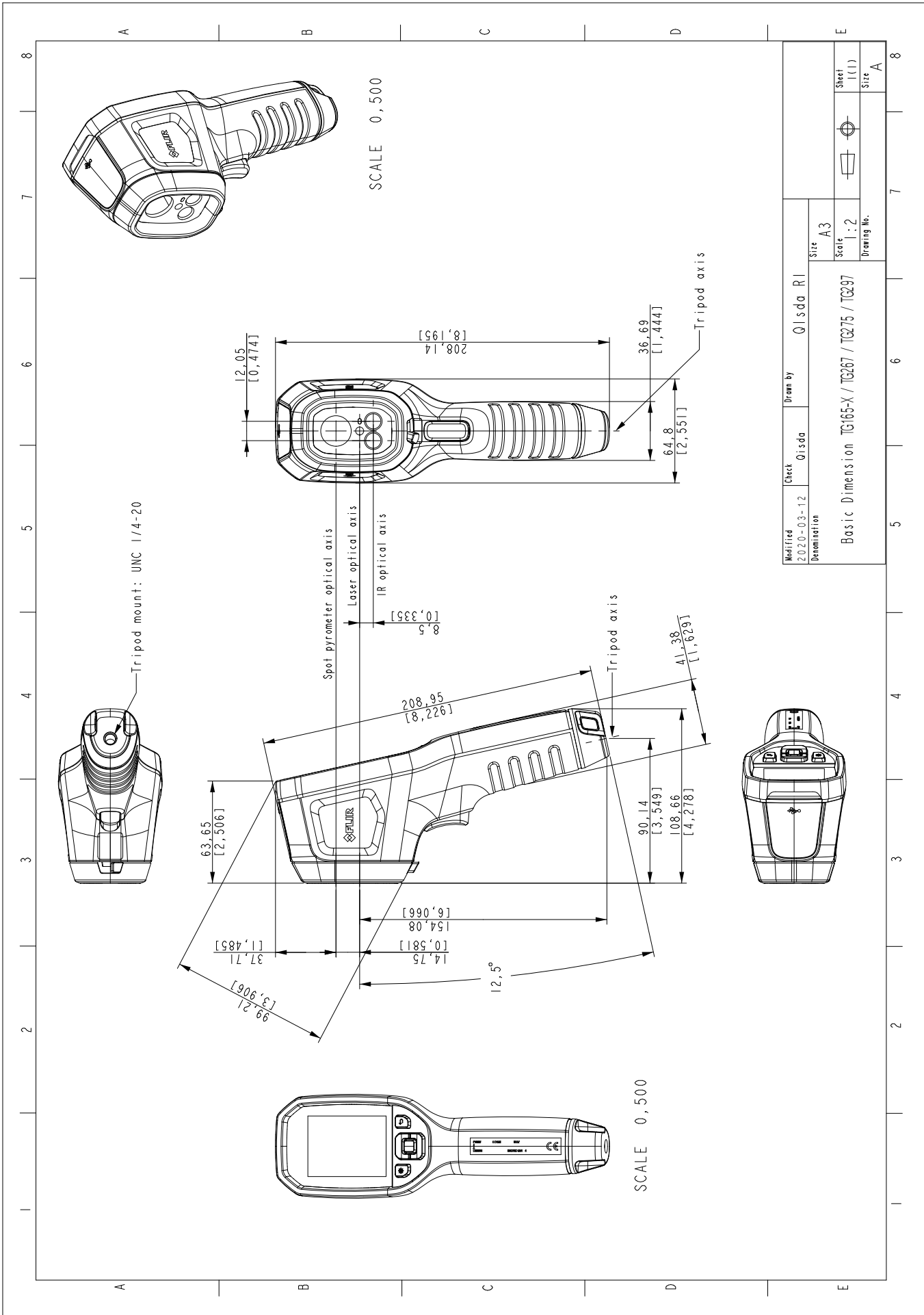

SCALE 0,500

SCALE 0,500

Modified	Checked	Drawn by	Q. Isda RI
2020-03-12	Q. Isda		
Denomination			Size A3
Basic Dimension TG165-X / TG267 / TG275 / TG297			Scale 1:2
			Drawing no.
			Sheet 1(1)
			Size A



The World's Sixth Sense™

July 1, 2020 Täby, Sweden

AQ320366

CE Declaration of Conformity – EU Declaration of Conformity

Product: FLIR TG267, TG275, TG297, TG165-X

Name and address of the manufacturer:

FLIR Systems AB

PO Box 7376

SE-187 15 Täby, Sweden

This declaration of conformity is issued under the sole responsibility of the manufacturer.

The object of the declaration: FLIR TG267, TG275, TG297, TG165-X.

TG165-X does not have a radio module.

The object of the declaration described above is in conformity with the relevant Union harmonisation legislation:

Directives:

Directive	2014/30/EU	Electromagnetic Compatibility
Directive	2014/53/EU	Radio Equipment Directive RED (N/A for TG165-X)
Directive	2011/65/EU	RoHS and 2015/830/EU

Standards:

EMC:	EN 61326-1:2013	EMC control and laboratory use – General reqs
	Draft EN 301489-1 v2.2.0:2017-03	EMC for radio equipment – Common tech reqs
	Draft EN 301489-17 v3.2.0:2017-03	ERM – EMC for radio eq – Wideband HIPERLAN
Laser:	EN 60825-1	Safety of laser products
RF exposure:	EN 62479:2010	Harmonized EN covering essential requirements of the R&TTE Directive
Radio:	EN 300 328 v2.1.1	Information technology equipment
Safety:	UL 60950-1, 3 rd Ed	

FLIR Systems AB

Quality Assurance

Lea Dabiri

Quality Manager

Material Safety Data Sheet

产品安全技术说明书

Section 1 Chemical Product and Company Identification

一、产品名称及企业标识

Product information: 产品信息

Battery Model: S18650-3000-1S1P

电池型号: S18650-3000-1S1P

Voltage: 3.6 V

电压: 3.6 V

Battery Capacity: 3000 mAh

电池容量: 3000 mAh

Manufacturer: Shenzhen Zhuoneng New Energy Co.,Ltd

生产厂家: 深圳市卓能新能源股份有限公司

Address : Tongfuyu Industry Park 6 Fuping Rd., Pingdong, Pingdi St., Longgang, Shenzhen 518000 P R China

地址: 广东省深圳市龙岗区坪地街道富坪中路六号同富裕工业园 A4 栋

Telephone: 0755-84072583

电话: 0755-84072583

FAX:0755-84071386

E-mail: 1720114179@qq.com

Section 2 Composition/Information on Ingredients

二、成分/组成

Chemical Composition 化学成分	CAS NO.	EC#	Weight (%) 重量
LiNi _x Co _y Mn _z O ₂ 镍钴锰酸锂	--	--	30-37
Graphite 石墨	7782-42-5	231-955-3	15-20
Garbon black 导电炭黑	1333-86-4	215-609-9	0-1

深圳市卓能新能源股份有限公司

Shenzhen Zhuoneng New Energy Co.,Ltd

页次 Page: 2 Of 7

生效日期 Date: 2019-03-13

Polyvinylidene fluoride resin 聚偏氟乙烯树脂	24937-79-9	607-458-6	0-1
Phosphate(1-),hexafluoro-,lithium 六氟磷酸锂	21324-40-3	244-334-7	12-16
Polypropylene 聚丙烯	9003-07-0	618-352-4	6-10
Aluminium 铝	7429-90-5	231-072-3	2-5
Copper 铜	7440-50-8	231-159-6	5-10
Iron 铁	7439-89-6	231-096-4	10-15

Section 3 Hazards Identification

三、危险性描述

The lithium ion batteries are not hazardous when used according to the Instructions of manufacturer under normal conditions. In case of abuse, there's a risk of explode, rupture, fire, heat, leakage of internal components, which could cause casualty loss. Abuses include but not limited to the following cases: charge for a long time, short circuit, put into fire, whack with hard object, puncture with acute object, crush, break.

正常情况下，按照生产商提供的说明使用是无危险的，在滥用的情况下可能会导致内部物质泄漏、发热、起火、外壳开裂等情况发生造成人员伤害和财产损失。滥用情况包括但不限于以下情况：长时间充电、短路、放入火中、硬物敲击、尖锐物体刺穿、挤压、弯曲折断等。

Section 4 First-aid Measures

四、急救方法

The lithium ion batteries are not hazardous with eye and skin contact under normal circumstance. In case of fire or rupture, the leakage of internal hazardous substance and formation of hazardous substance would occur, take the following measures if contact with it:

正常使用情况下，接触眼睛、皮肤不会造成危害。如果电池着火或者开裂，会导致内部有害物质和生成有害物质，如有接触。采取以下措施：

After eye contact

Check for and remove any contact lenses. Immediately flush with plenty of clean water for at least 15 minutes, seek medical assistance;

眼睛接触后，立刻用大量流动清水冲洗至少 15 分钟，及时就医；

After skin contact

Immediately flush with plenty of clean water for at least 15 minutes, seek medical

assistance if severe;

皮肤接触后，立刻用大量流动清水冲洗至少 15 分钟，如果情况严重及时就医；

After inhalation

If inhaled, remove to fresh air immediately, seek medical assistance, and ventilate the contaminated area;

吸入后，立刻转移到有新鲜空气的地方，就医并对污染区域通风；

After swallowing

Do not induce vomiting. Get medical attention.

不要立即催吐，寻求医生帮助。

Section 5 Fire Fighting Measures

五、 消防措施

Extinguish with plenty of water, dry powder extinguishers, sands, earth. Combustion products and decomposed products by contact of water or air with internal substance include: carbon monoxide, carbon dioxide, hydrogen fluoride, phosphorus fluoride.

可用大量水、干粉灭火器、沙子、土等灭火，燃烧产物和内部物质和空气水接触生成：CO、CO₂、HF、氟氧化磷等等

Section 6 Accidental Release Measures

六、 泄露应急处理方法

When leakage of batteries happens, liquid could be absorbed with sands, earth or other inert substance, and the contaminated area should be ventilated meantime.

电池内部物质泄露，用沙子、土等惰性物质吸收并及时通风

Section 7 Handling and Storage

七、 操作和存储

Precautions for safe handling:

Consumption of food and beverage should be avoided in work areas.

Wash hands with soap and water before eating, drinking.

安全操作注意事项：

工作场所应避免食用食品和饮料。吃东西、喝东西前要用肥皂和清水洗手。

Batteries may explode or cause burns, if disassembled, crushed or exposed to fire or high temperatures. Do not short or install with incorrect polarity.

电池可能会爆炸或引起烧伤，如果拆卸，压碎或暴露在火或高温。不要短接或正负极接反。

Store in a cool, dry, well-ventilated place.

储存于阴凉、干燥、通风良好的地方。

Keep away from heat, avoiding the long time of sunlight.

远离热量，避免长时间的阳光照射。

Section 8 Exposure Controls/Personal Protection

八、 暴露控制/个人防护

There is no need for protect under normal condition. In engineering aspect, ventilation equipment should be installed. Gas mask, blinkers, gloves enduring chemical erosion and exposure suit are required when dealing with fire and leakage.

在正常情况下不需要保护。在工程中应安装通风设备。在处理火灾和泄漏时，需要防毒面具、百叶窗、手套、耐化学腐蚀和暴露服。

Section 9 Physical and Chemical Properties

九、 理化性质

Batteries are not single chemical material, there are no specific physical and chemical properties such as melting point and boiling point.

电池不是单一的化学品，不具备特定的理化性质。

Section 10 Stability and Reactivity

十、 稳定性和反应性

Conditions to Avoid:Flames, sparks, and other sources of ignition, incompatible materials.

避免条件:火焰、火花等火源、不相容材料。

Incompatibilities materials: Oxidizing agents, acid, base.

不相容材料:氧化剂、酸、碱。

Hazardous decomposition products:Carbon monoxide, carbon dioxide, lithium oxide fumes.

有害分解产品:一氧化碳、二氧化碳、氧化锂烟雾。

Section 11 Toxicological Information

十一、毒理学资料

Acute Toxicity 急性毒性

CAS No.	LC50/LD50
7782-42-5	No data available
1333-86-4	No data available
24937-79-9	No data available
21324-40-3	No data available
9003-07-0	No data available
7429-90-5	No data available
7440-50-8	No data available
7439-89-6	No data available

Section 12 Ecological Information

十二、生态学资料

There is no influence to ecology and environment when used properly
正常使用电池不会对生态环境造成影响

Section 13 Disposal Considerations

十三、处理注意事项

Recommendation: Consult state, local or national regulations to ensure proper disposal.

建议:参考国家、地方或国家法规,以确保适当的处置。

Disposal must be made according to official regulations.

处置必须按照官方规定进行。

Section 14 Transport Information

十四、运输信息

Exceeds the standard of Table 965-II, so it belongs to dangerous goods. According to the Packing Instruction 965 section IB of IATA DGR 60th Edition for transportation, Cargon aircraft only.

超过表 965-II 的标准,属于危险品。根据国际航空运输协会 DGR 60 号 Edition 的包装说明书第 965 节,只适用于货运飞机。

According to the special provision 188 of IMDG(38-16) or the special provision 188 of <<Recommendations On The Transport Of Dangerous Goods-Model Regulations>>(20th).

深圳市卓能新能源股份有限公司

Shenzhen Zhuoneng New Energy Co.,Ltd

页次 Page: 6 Of 7

生效日期 Date: 2019-03-13

The goods are not subject to other provision of this code.

根据《国际危规公约》(38-16)第 188 条或《关于危险品模型运输的建议》第 188 条(第 20 条)。货物不受本准则其他规定的约束。

Separate batteries to prevent short-circuiting. And they should be packed in strong package during transport. Lithium cell or battery should incorporate a safety venting device or be designed to prevent a violent rupture under normal transport conditions. Keep away from high temperature and open flames. Lithium ion cells and batteries must be offered for transport at a state of charge(SoC) not exceeding 30% of their rated capacity.

分开电池以防止短路。而且在运输过程中，它们应该用结实的包装来包装。锂电池或电池应该装有安全排气装置，或设计成在正常运输条件下防止剧烈断裂。远离高温和明火。锂离子电池和电池必须以不超过其额定容量 30%的状态进行运输。

Transport Fashion:By air, by sea, by railway, by road.

运输方式:空运、海运、铁路、陆路。

Section 15 Regulatory Information

十五、法规信息

Safety, health and environmental regulations/legislation specific for the substance or mixture

特定于物质或混合物的安全、健康和环境法规

CAS No.	TSCA	IECSC	DSL/NDSL	EINECS/ELINCS/NLP
7782-42-5	Listed	Listed	Listed DSL	Listed
1333-86-4	Listed	Listed	Listed DSL	Listed
24937-79-9	Listed	Listed	Listed DSL	Listed
21324-40-3	Listed	Listed	Listed DSL	Listed
9003-07-0	Listed	Listed	Listed DSL	Listed
7429-90-5	Listed	Listed	Listed DSL	Listed
7440-50-8	Listed	Listed	Listed DSL	Listed
7439-89-6	Listed	Listed	Listed DSL	Listed

Section 16 Other Information

十六、 其他信息

Notice to reader

To the best of our knowledge, the information contained herein is accurate. However, neither the above named supplier nor any of its subsidiaries assumes any liability whatsoever for the accuracy or completeness of the information contained herein.

据我们所知，这里所包含的信息是准确的。然而，上述指定供应商或其任何子公司均不对本协议所载信息的准确性或完整性承担任何责任。

Final determination of suitability of any material is the sole responsibility of the user. All materials may present unknown hazards and should be used with caution. Although certain hazards are described herein, we can not guarantee that these are the only hazards that exist.

任何材料的适用性的最终确定是用户的唯一责任。所有材料可能存在未知的危险，应谨慎使用。虽然这里描述了某些危害，但我们不能保证这些是唯一存在的危害。

End of report



中国认可
国际互认
检测
TESTING
CNAS L0357

检测报告

Test Report

报告编号 (Report No.) : S19-B0337-1

产品名称(Product Name): 可充式锂离子电池组

Rechargeable Lithium-ion Battery Pack

型号 (Model/Type) : S18650-3000-1S1P

委托方(Client) : 佳世达科技股份有限公司

Qisda Corporation

中国电子技术标准化研究院赛西实验室

China Electronics Standardization Institute (CESI) Laboratory



检测报告 Test Report

报告编号 (Report No.): S19-B0337-1

共 14页 (Page 1 of 14)

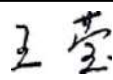
产品名称 Product Name	可充式锂离子电池组 Rechargeable Lithium-ion Battery Pack	委托方 Client	佳世达科技股份有限公司 Qisda Corporation
型号规格 Model/Type	S18650-3000-1S1P, 3.6V, 3000mAh, 10.8Wh	委托方地址 Client Address	333 桃园市龟山区山莺路 157 号 157 Shan-ying Road, Gucishan Taoyuan 333, Taiwan
样品数量 Sample Quantity	单一电池电池组 18, 电池 25 18 single cell batteries, 25 cells	制造商 Manufacturer	深圳市卓能新能源股份有限公司 Shenzhen Zhuoneng New Energy Co.,Ltd
样品来源 Sample Source	送样 Submitted by Manufacturer	制造商地址 Manufacturer Address	广东省深圳市龙岗区坪地街道富坪中路六号同富裕工业园 Tongfuyu Industrial Park, No.6, Fuping Middle Road, Pingdong Community, Longgang District, Shenzhen City, Guangdong Province
收样日期 Receipt Sample Date	2019.04.15	生产厂 Factory	深圳市卓能新能源股份有限公司 Shenzhen Zhuoneng New Energy Co.,Ltd
试验类别 Testing Kind	委托试验 Entrusted Test	生产厂地址 Factory Address	广东省深圳市龙岗区坪地街道富坪中路六号同富裕工业园 Tongfuyu Industrial Park, No.6, Fuping Middle Road, Pingdong Community, Longgang District, Shenzhen City, Guangdong Province
检验日期 Testing Date	开始时间 (Start Date): 2019.04.16 结束时间 (Complete Date): 2019.04.26		
试验环境 Testing Environment	温度(Temperature): (22.2~24.9) °C; 湿度(Humidity): (40~68) %R.H.; 大气压力(Atmospheric Pressure): 101kPa		
试验标准 /方法 Testing Standard /Method	UN 38.3, Rev.6 《关于危险货物运输的建议书—试验和标准手册》第三部分 38.3 节《金属锂电池和锂离子电池组》 "Recommendations on the TRANSPORT OF DANGEROUS GOODS-Manual of Tests and Criteria", Sixth revised edition, Part III, 38.3 "Lithium metal and lithium ion batteries"(UN 38.3).		
试验概况与分析 Testing Description	根据 UN 38.3 《关于危险货物运输的建议书—试验和标准手册》第三部分 38.3 节《金属锂电池和锂离子电池组》，对电池组进行了高度模拟试验、温度试验、振动试验、冲击试验、外部短路试验以及过度充电试验，对其元件电池进行了撞击试验以及强制放电试验。 According to UN 38.3, batteries are subjected to Altitude simulation, Thermal test, Vibration, Shock, External short circuit and the Overcharge test, its component cells are subjected to Impact and Forced discharge test.		
试验结论 Verdict	符合要求 Qualified		
试验 Tested by		日期 (Date): 2019.04.29	
审核 Checked by		日期 (Date): 2019.04.29	
批准 Approved by		日期 (Date): 2019.04.30	
	郭建宇 Guo Jianyu: 质量负责人 Quality Manager 王莹 Wang Ying: 技术负责人 Technical Manager 何鹏林 He Penglin: 副主任 Vice Director		
注: 判定栏中“P”表示合格, “N”表示不适用或未进行, “F”表示不合格, “—”表示不做判定。 Notes: In verdict column, “P” means pass, “N” means no application, “F” means fail, “—” means no Verdict.			

样品描述及说明 General product information

样品类型 (Sample Type):

是否可充电 Rechargeable or not	是 YES
------------------------------	----------

<input type="checkbox"/> 电池 Cell	用途 Use	—	化学组分 Electrochemistry System	—
<input checked="" type="checkbox"/> 单一电池 电池组 Single cell Battery	用途 Use	电子产品 Electrical Products	型号 Battery Model	S18650-3000-1S1P
	组成方式 Composing Mode	1 串 1 并 1S1P	电池化学组分 Electrochemistry System	三元材料 Li(NiCoMn)O ₂
	电池生产厂 Manufacturer of Cell	深圳市卓能新能源股份有限公司 Shenzhen Zhuoneng New Energy Corporation limited		
	电池型号 Cell Model	18650	电池容量 Cell Capacity	3000mAh

样品参数:

标称电压 Nominal Voltage	3.6V	额定容量 Rated Capacity	3000mAh	额定能量 Rated Energy	10.8Wh
充电限制电压 Max. Charging Voltage	4.35V	最大连续充电电流 Max. Charging Current	1500mA	充电电流 Charging Current	600mA
放电终止电压 Discharge Cut-off Voltage	2.75V	最大放电电流 Max. Discharging Current	1500mA	充电截止电流 Charge Cut-off Current	60mA

测试项目、样品及顺序 Test items, sample and Order

测试编号 Test No.	测试项目 Test Items	样品编号 Sample No.	结论 Verdict
T1	高度模拟 Altitude simulation	A1~A10	P
T2	温度试验 Thermal test	A1~A10	P
T3	振动 Vibration	A1~A10	P
T4	冲击 Shock	A1~A10	P
T5	外短路 External short circuit	A1~A10	P
T6	撞击/挤压 Impact / Crush	C1~C5	P
T7	过度充电 Overcharge	A11~A14, B1~B4	P
T8	强制放电 Forced discharge	D1~D10, E1~E10	P

样品的预处理: A1~A14 为 1 次循环完全充电状态; B1~B4 为 50 次循环完全充电状态; C1~C5 为 1 次循环 50% 额定容量; D1~D10: 1 次循环完全放电状态; E1~E10: 50 次循环完全放电状态。其中: A1~A14、B1~B4 为电池组, C1~C5、D1~D10、E1~E10 为其元件电池。

Pretreatment of the samples: A1~A14 in first cycle in fully charged states; B1~B4: in after 50 cycles ending in fully charged states; C1~C5: in first cycle at 50% of the design rated capacity; D1~D10: in first cycle in fully discharged states; E1~E10: in after 50 cycles in fully discharged states.

NOTES: A1~A14, B1~B4 are batteries, C1~C5, D1~D10, E1~E10 are component cells.

试验顺序:

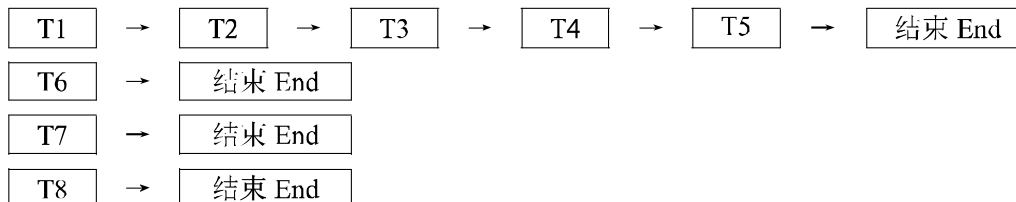

UN 38.3 测试方法、数据及结果 Test method and data

电池或锂离子电池组质量 Mass of cell or battery (M)	质量损失限值 Mass loss limit
M < 1g	0.5%
1 g ≤ M ≤ 75g	0.2%
M > 75g	0.1%

38.3.4.1 试验 T.1: 高度模拟 Test T.1: Altitude simulation P

38.3.4.1.1 目的
 本试验模拟在低压条件下的空运。

38.3.4.1.2 试验程序
 试验电池和电池组应在压力等于或低于 11.6 千帕和环境温度 (20±5) °C 下存放至少 6 小时。

38.3.4.1.3 要求
 如果无渗漏、无排气、无解体、无破裂和无起火, 并且每个试验电池或电池组在试验后的开路电压不小于其在进行这一试验前电压的 90%。电池和电池组即符合这一要求。有关电压的要求不适用于完全放电状态的试验电池和电池组。

38.3.4.1.1 Purpose
 This test simulates air transport under low-pressure conditions.

38.3.4.1.2 Test procedure
 Test cells and batteries shall be stored at a pressure of 11.6 kPa or less for at least six hours at ambient temperature (20±5)°C.

38.3.4.1.3 Requirement
 Cells and batteries meet this requirement if there is no mass loss, no leakage, no venting, no dis assembly, no rupture and no fire and if the open circuit voltage of each test cell or battery after testing is not less than 90% of its voltage immediately prior to this procedure. The requirement relating to voltage is not applicable to test cells and batteries at fully discharged states.

样品 编号 Sample No.	试验前 Before test		试验后 After test		质量亏损 Mass loss (%)	电压亏损 Voltage loss (%)	判定: 是否符合要求 Verdict
	质量(g) Mass	电压(V) Voltage	质量(g) Mass	电压(V) Voltage			
A1	48.168	4.302	48.166	4.279	0.00	0.53	P
A2	47.984	4.309	47.982	4.284	0.00	0.58	P
A3	47.983	4.308	47.982	4.284	0.00	0.56	P
A4	48.137	4.309	48.135	4.285	0.00	0.56	P
A5	48.075	4.300	48.073	4.277	0.00	0.53	P
A6	47.928	4.306	47.926	4.282	0.00	0.56	P
A7	47.995	4.303	47.992	4.279	0.01	0.56	P
A8	48.172	4.308	48.172	4.284	0.00	0.56	P
A9	47.964	4.300	47.963	4.277	0.00	0.53	P
A10	47.966	4.306	47.965	4.282	0.00	0.56	P

UN 38.3 测试方法、数据及结果 Test method and data

38.3.4.2 试验 T.2: 温度试验 Test T.2: Thermal test							P
<p>38.3.4.2.1 目的 本试验评估电池和锂离子电池组的密封完善性和内部电连接。试验是利用迅速和极端的温度变化进行的。</p> <p>38.3.4.2.2 试验程序 试验电池和电池组应先在试验温度等于 $(72 \pm 2)^\circ\text{C}$ 下存放至少 6 小时,接着再在试验温度等于 $(-40 \pm 2)^\circ\text{C}$ 下存放至少 6 小时。两个极端试验温度之间的最大时间间隔为 30 分钟。此一程序重复进行,共完成 10 次,接着将所有试验电池和电池组在环境温度 $(20 \pm 5)^\circ\text{C}$ 下存放 24 小时。对于大型电池和电池组,暴露于极端试验温度的时间至少应为 12 小时。</p> <p>38.3.4.2.3 要求 如果无渗漏、无排气、无解体、无破裂和无起火,并且每个试验电池或电池组在试验后的开路电压不小于其在进行这一试验前电压的 90%。电池和电池组即符合这一要求。有关电压的要求不适用于完全放电状态的试验电池和电池组。</p> <p>38.3.4.2.1 Purpose This test assesses cell and battery seal integrity and internal electrical connections. The test is conducted using rapid and extreme temperature changes.</p> <p>38.3.4.2.2 Test procedure Test cells and batteries are to be stored for at least six hours at a test temperature equal to $(72 \pm 2)^\circ\text{C}$, followed by storage for at least six hours at a test temperature equal to $(-40 \pm 2)^\circ\text{C}$. The maximum time interval between test temperature extremes is 30 minutes. This procedure is to be repeated 10 times, after which all test cells and batteries are to be stored for 24 hours at ambient temperature $(20 \pm 5)^\circ\text{C}$. For large cells and batteries the duration of exposure to the test temperature extremes should be at least 12 hours.</p> <p>38.3.4.2.3 Requirement Cells and batteries meet this requirement if there is no mass loss, no leakage, no venting, no dis assembly, no rupture and no fire and if the open circuit voltage of each test cell or battery after testing is not less than 90% of its voltage immediately prior to this procedure. The requirement relating to voltage is not applicable to test cells and batteries at fully discharged states.</p>							
样品 编号 Sample No.	试验前 Before test		试验后 After test		质量亏损 Mass loss (%)	电压亏损 Voltage loss (%)	判定: 是否符合要求 Verdict
	质量(g) Mass	电压(V) Voltage	质量(g) Mass	电压(V) Voltage			
A1	48.166	4.279	48.159	4.133	0.01	3.41	P
A2	47.982	4.284	47.976	4.132	0.01	3.55	P
A3	47.982	4.284	47.976	4.132	0.01	3.55	P
A4	48.135	4.285	48.126	4.133	0.02	3.55	P
A5	48.073	4.277	48.066	4.132	0.01	3.39	P
A6	47.926	4.282	47.920	4.133	0.01	3.48	P
A7	47.992	4.279	47.987	4.133	0.01	3.41	P
A8	48.172	4.284	48.165	4.132	0.01	3.55	P
A9	47.963	4.277	47.956	4.132	0.01	3.39	P
A10	47.965	4.282	47.960	4.131	0.01	3.53	P

UN 38.3 测试方法、数据及结果 Test method and data

38.3.4.3 试验 T.3: 振动 Test T.3: Vibration					P		
<p>38.3.4.3.1 目的 本试验模拟运输过程中的振动。</p> <p>38.3.4.3.2 试验程序 电池和电池组紧固于振动机平台，但不得造成电池变形，并能准确可靠地传播振动。振动应是正弦波形，频率在 7 赫兹和 200 赫兹之间，再回到 7 赫兹，跨度为 15 分钟。这一振动过程须对三个互相垂直的电池安装方位的每一个方向都重复进行 12 次，总共为时 3 小时。其中一个振动方向必须与端面垂直。作对数式频率扫描，对总质量不足 12 千克的电池和电池组（电池和小型电池组），和对 12 千克及更大的电池组（大型电池组）有所不同。 对电池和小型电池组：从 7 赫兹开始，保持 1g_n 的最大加速度，直到频率达到 18 赫兹。然后将振幅保持在 0.8 毫米（总偏移 1.6 毫米），并增加频率直到最大加速度达到 8g_n（频率约为 50 赫兹）。将最大加速度保持在 8g_n 直到频率增加到 200 赫兹。</p> <p>38.3.4.3.3 要求 如果试验中和试验后无渗漏、无排气、无解体、无破裂和无起火，并且每个试验电池或电池组在第三个垂直安装方位上的试验后的立即测得的开路电压不小于在进行这一试验前电压的 90%。电池和电池组即符合本项要求。有关电压的要求不适用于完全放电状态的试验电池和电池组。</p> <p>38.3.4.3.1 Purpose This test simulates vibration during transport.</p> <p>38.3.4.3.2 Test procedure Cells and batteries are firmly secured to the platform of the vibration machine without distorting the cells in such a manner as to faithfully transmit the vibration. The vibration shall be a sinusoidal waveform with a logarithmic sweep between 7 Hz and 200 Hz and back to 7 Hz traversed in 15 minutes. This cycle shall be repeated 12 times for a total of 3 hours for each of three mutually perpendicular mounting positions of the cell. One of the directions of vibration must be perpendicular to the terminal face. The logarithmic frequency sweep shall differ for cells and batteries with a gross mass of not more than 12 kg (cells and small batteries), and for batteries with a gross mass of more than 12 kg (large batteries). For cells and small batteries: from 7 Hz a peak acceleration of 1 g_n is maintained until 18 Hz is reached. The amplitude is then maintained at 0.8 mm (16 mm total excursion) and the frequency increased until a peak acceleration of 8 g_n occurs (approximately 50 Hz). A peak acceleration of 8 g_n is then maintained until the frequency is increased to 200 Hz.</p> <p>38.3.4.3.3 Requirement Cells and batteries meet this requirement if there is no mass loss, no leakage, no venting, no disassembly, no rupture and no fire and if the open circuit voltage of each test cell or battery after testing is not less than 90% of its voltage immediately prior to this procedure. The requirement relating to voltage is not applicable to test cells and batteries at fully discharged states.</p>							
样品 编号 Sample No.	试验前 Before test		试验后 After test		质量亏损 Mass loss (%)	电压亏损 Voltage loss (%)	判定：是否符合要求 Verdict
	质量(g) Mass	电压(V) Voltage	质量(g) Mass	电压(V) Voltage			
A1	48.159	4.133	48.154	4.132	0.01	0.02	P
A2	47.976	4.132	47.968	4.131	0.02	0.02	P
A3	47.976	4.132	47.971	4.131	0.01	0.02	P
A4	48.126	4.133	48.120	4.132	0.01	0.02	P
A5	48.066	4.132	48.062	4.132	0.01	0.00	P
A6	47.920	4.133	47.918	4.132	0.00	0.02	P
A7	47.987	4.133	47.979	4.132	0.02	0.02	P
A8	48.165	4.132	48.162	4.131	0.01	0.02	P
A9	47.956	4.132	47.951	4.131	0.01	0.02	P
A10	47.960	4.131	47.956	4.130	0.01	0.02	P

UN 38.3 测试方法、数据及结果 Test method and data

38.3.4.4 试验 T.4: 冲击 T.4: Shock P

38.3.4.4.1 目的
本试验模拟运输过程中可能发生的撞击。

38.3.4.4.2 试验程序
电池和电池组用坚硬支架紧固在试验装置上，支架支撑着每个试验电池组的所有安装面。每个电池须经受最大加速度 150g_r 和脉冲持续时间 6 毫秒的半正弦波冲击。另外，每个大型电池须经受最大加速度 50g_r 和脉冲持续时间 11 毫秒的半正弦波冲击。每个电池组应根据电池组的质量而经受不同最大加速度的半正弦波冲击。

电池组	最大加速度	脉冲持续时间
小型电池组	150g _r 或加速度 (g _r) = $\sqrt{\frac{100850}{\text{质量}}}$ 中的较小者	6ms
大型电池组	50g _r 或加速度 (g _r) = $\sqrt{\frac{30000}{\text{质量}}}$ 中的较小者	11ms

注：质量以公斤表示。

每个电池组须在一个互相垂直的电池或电池组安装方位的正方向经受三次冲击，接着在反方向经受三次冲击，总共经受 18 次冲击。

38.3.4.4.3 要求
如果无渗漏、无排气、无解体、无破裂和无起火，并且每个试验电池或电池组在试验后的开路电压不小于其在进行这一试验前电压的 90%。电池和电池组即符合这一要求。有关电压的要求不适用于完全放电状态的试验电池和电池组。

38.3.4.4.1 Purpose
This test simulates possible impacts during transport.

38.3.4.4.2 Test procedure
Test cells and batteries shall be secured to the testing machine by means of a rigid mount which will support all mounting surfaces of each test battery.
Each cell shall be subjected to a half-sine shock of peak acceleration of 150 g_n and pulse duration of 6 milliseconds. Alternatively, large cells may be subjected to a half-sine shock of peak acceleration of 50 g_n and pulse duration of 11 milliseconds.

Each battery shall be subjected to a half-sine shock of peak acceleration depending on the mass of the battery. The pulse duration shall be 6 milliseconds for small batteries and 11 milliseconds for large batteries. The formulas below are provided to calculate the appropriate minimum peak accelerations.

38.3.4.4.3 Requirement
Cells and batteries meet this requirement if there is no mass loss, no leakage, no venting, no dis assembly, no rupture and no fire and if the open circuit voltage of each test cell or battery after testing is not less than 90% of its voltage immediately prior to this procedure. The requirement relating to voltage is not applicable to test cells and batteries at fully discharged states.

样品 编号 Sample No.	试验前 Before test		试验后 After test		质量亏损 Mass loss (%)	电压亏损 Voltage loss (%)	判定：是否符合要求 Verdict
	质量(g) Mass	电压(V) Voltage	质量(g) Mass	电压(V) Voltage			
A1	48.154	4.132	48.154	4.132	0.00	0.00	P
A2	47.968	4.131	47.968	4.130	0.00	0.02	P
A3	47.971	4.131	47.971	4.130	0.00	0.02	P
A4	48.120	4.132	48.120	4.132	0.00	0.00	P
A5	48.062	4.132	48.062	4.132	0.00	0.00	P
A6	47.918	4.132	47.918	4.130	0.00	0.05	P
A7	47.979	4.132	47.979	4.132	0.00	0.00	P
A8	48.162	4.131	48.162	4.130	0.00	0.02	P
A9	47.951	4.131	47.951	4.130	0.00	0.02	P
A10	47.956	4.130	47.956	4.130	0.00	0.00	P

UN 38.3 测试方法、数据及结果 Test method and data

38.3.4.5 试验 T.5: 外部短路 T.5: External short circuit	P
---	---

38.3.4.5.1 目的

本试验模拟外部短路。

待试验电池或电池组经一段时间的加热后，使其外壳温度稳定到 $57 \pm 4^\circ\text{C}$ 。加热时间取决于电池或电池组的大小和设计，并进行评估和记录。如果无法评估，小型电池和电池组应至少为 6h，大型电池和电池组应至少为 12h。然后使电池或电池组在 $57 \pm 4^\circ\text{C}$ 下经受总外部电阻小于 0.1 欧姆的短路条件。

这一短路条件应在电池或电池组外壳温度回到 $57 \pm 4^\circ\text{C}$ 后继续至少 1 小时，对大型电池组，温度下降到最高温升值的一半，并要低于该值。

短路和温度下降过程应在试验环境温度条件下进行。

38.3.4.5.3 要求

如果外壳温度不超过 170°C ，并且在试验过程中及试验后 6 小时内无解体、无破裂，无起火，电池和电池组即符合本项要求。

38.3.4.5.1 Purpose

This test simulates an external short circuit.

38.3.4.5.2 Test procedure

The cell or battery to be tested shall be shall be heated for a period of time necessary to reach a homogeneous stabilized temperature of $57 \pm 4^\circ\text{C}$, measured on the external case. This period of time depends on the size and design of the cell or battery and should be assessed and documented. If this assessment is not feasible, the exposure time shall be at least 6 hours for small cells and small batteries, and 12 hours for large cells and large batteries. Then the cell or battery at $57 \pm 4^\circ\text{C}$ shall be subjected to one short circuit condition with a total external resistance of less than 0.1 ohm.

This short circuit condition is continued for at least one hour after the cell or battery external case temperature has returned to $57 \pm 4^\circ\text{C}$, or in the case of the large batteries, has decreased by half of the maximum temperature increase observed during the test and remains below that value.

The short circuit and cooling down phases shall be conducted at least at ambient temperature.

38.3.4.5.3 Requirement

Cells and batteries meet this requirement if their external temperature does not exceed 170°C and there is no disassembly, no rupture and no fire within six hours of this test.

样品编号 Sample No.	最高温度 (°C) Maximum Temperature	判定: 是否符合要求 Verdict
A1	57.1	P
A2	56.7	P
A3	58.3	P
A4	58.1	P
A5	57.0	P
A6	56.8	P
A7	57.1	P
A8	57.8	P
A9	57.4	P
A10	57.5	P

UN 38.3 测试方法、数据及结果 Test method and data

38.3.4.6 试验 T.6 A: 撞击 Test T.6 A: Impact	P
--	---

38.3.4.6.1 目的
 本节的试验模拟撞击或挤压等可能造成内部短路的机械性破坏。

38.3.4.6.2 试验程序—撞击 (适用于直径不小于 18 毫米的圆柱电池)
 试样电池或元件电池放在平坦表面上。一根 316 型不锈钢棒横放在试样中心，钢棒直径 15.8 毫米±0.1 毫米，长度至少 6 厘米，或电池最长端的尺度，取二者之长者。将一块 9.1 千克±0.1 千克的重锤从 61±2.5 厘米高处跌落到钢棒和试样交叉处，使用一个几乎没有摩擦的、对落体重锤阻力最小的垂直轨道或管道加以控制。垂直轨道或管道用于引导落锤沿与水平支撑表面呈 90 度落下。
 接受撞击的试样，纵轴应与平坦表面平行并与横放在试样中心的直径 15.8 毫米±0.1 毫米弯曲表面的纵轴垂直。每一试样只经受一次撞击。

38.3.4.6.4 要求
 如果外壳温度不超过 170℃，并且在试验过程中及试验后 6 小时内无解体、无破裂，无起火，电池和电池组即符合本项要求。

38.3.4.6.1 Purpose
 These tests simulate mechanical abuse from an impact or crush that may result in an internal short circuit.

38.3.4.6.2 Test procedure – Impact (applicable to cylindrical cells not less than 18 mm in diameter)
 The sample cell or component cell is to be placed on a flat smooth surface. A 15.8 mm ±0.1mm diameter, at least 6 cm long, or the longest dimension of the cell, whichever is greater, Type 316 stainless steel bar is to be placed across the centre of the sample. A 9.1 kg ± 0.1 kg mass is to be dropped from a height of 61 ± 2.5 cm at the intersection of the bar and sample in a controlled manner using a near frictionless, vertical sliding track or channel with minimal drag on the falling mass. The vertical track or channel used to guide the falling mass shall be oriented 90 degrees from the horizontal supporting surface.
 The test sample is to be impacted with its longitudinal axis parallel to the flat surface and perpendicular to the longitudinal axis of the 15.8 mm ± 0.1mm diameter curved surface lying across the centre of the test sample. Each sample is to be subjected to only a single impact.

38.3.4.6.4 Requirement
 Cells and component cells meet this requirement if their external temperature does not exceed 170 °C and there is no dis assembly and no fire during the test and within six hours after this test.

样品编号 Sample No.	最高温度 (°C) Maximum Temperature	判定: 是否符合要求 Verdict
C1	72.6	P
C2	84.0	P
C3	75.2	P
C4	75.8	P
C5	78.1	P

UN 38.3 测试方法、数据及结果 Test method and data

<p>38.3.4.6 试验 T.6 B: 挤压 Test T.6 B: Crush</p>	N																		
<p>38.3.4.6.1 目的 本节的试验模拟撞击或挤压等可能造成内部短路的机械性破坏。</p> <p>38.3.4.6.3 试验程序—挤压 (适用于棱柱形、袋装、硬币/纽扣电池和直径小于 18 毫米的圆柱形电池) 注: 此处直径指设计参数(例如, 18650 电池的直径为 18.0 毫米)。 将电池或元件电池放在两个平面之间挤压, 挤压力度逐渐加大, 在第一个接触点上的速度大约为 1.5 厘米/秒。挤压持续进行, 直到出现以下三种情况之一:</p> <ul style="list-style-type: none"> (a) 施加的力量达到 13±0.78 千牛; 例如: 用一个活塞直径 32 毫米的液压顶施力, 直至液压顶的压力达到 17 兆帕。 (b) 电池电压下降至少 100 毫伏; 或 (c) 电池变形达到原始厚度的 50%或以上。 <p>一旦达到最大压力, 电压下降 100 毫伏或更多, 或电池变形至少达原厚度的 50%, 即可解除压力。棱柱形或袋装电池应从最宽的一面施压。纽扣/硬币形电池应从平坦表面施压。圆柱形电池应从纵轴垂直的方向施压。</p> <p>每个试样电池或元件电池只做一次挤压试验。试样应继续观察 6 小时。试验应使用之前未做过其他试验的电池或元件电池。</p> <p>38.3.4.6.4 要求 如果外壳温度不超过 170℃, 并且在试验过程中及试验后 6 小时内无解体、无破裂, 无起火, 电池和元件电池即符合本项要求。</p> <p>38.3.4.6.1 Purpose These tests simulate mechanical abuse from an impact or crush that may result in an internal short circuit.</p> <p>38.3.4.6.3 Test Procedure – Crush (applicable to prismatic, pouch, coin/button cells and cylindrical cells less than 18 mm in diameter) <i>NOTE: Diameter here refers to the design parameter (for example the diameter of 18 650 cells is 18.0 mm).</i> A cell or component cell is to be crushed between two flat surfaces. The crushing is to be gradual with a speed of approximately 1.5 cm/s at the first point of contact. The crushing is to be continued until the first of the three options below is reached.</p> <ul style="list-style-type: none"> (a) The applied force reaches 13 kN ± 0.78 kN; Example: The force shall be applied by a hydraulic ram with a 32 mm diameter piston until a pressure of 17 MPa is reached on the hydraulic ram. (b) The voltage of the cell drops by at least 100 mV; or (c) The cell is deformed by 50% or more of its original thickness. <p>Once the maximum pressure has been obtained, the voltage drops by 100 mV or more, or the cell is deformed by at least 50% of its original thickness, the pressure shall be released.</p> <p>A prismatic or pouch cell shall be crushed by applying the force to the widest side. A button/coin cell shall be crushed by applying the force on its flat surfaces. For cylindrical cells, the crush force shall be applied perpendicular to the longitudinal axis.</p> <p>Each test cell or component cell is to be subjected to one crush only. The test sample shall be observed for a further 6 h. The test shall be conducted using test cells or component cells that have not previously been subjected to other tests.</p> <p>38.3.4.6.4 Requirement Cells and component cells meet this requirement if their external temperature does not exceed 170 °C and there is no dis assembly and no fire during the test and within six hours after this test.</p>																			
<table border="1" style="width: 100%; border-collapse: collapse;"> <thead> <tr> <th style="width: 20%;">样品编号 Sample No.</th> <th style="width: 30%;">最高温度 (°C) Maximum Temperature</th> <th style="width: 50%;">判定: 是否符合要求 Verdict</th> </tr> </thead> <tbody> <tr><td style="text-align: center;">—</td><td style="text-align: center;">—</td><td style="text-align: center;">—</td></tr> <tr><td style="text-align: center;">—</td><td style="text-align: center;">—</td><td style="text-align: center;">—</td></tr> <tr><td style="text-align: center;">—</td><td style="text-align: center;">—</td><td style="text-align: center;">—</td></tr> <tr><td style="text-align: center;">—</td><td style="text-align: center;">—</td><td style="text-align: center;">—</td></tr> <tr><td style="text-align: center;">—</td><td style="text-align: center;">—</td><td style="text-align: center;">—</td></tr> </tbody> </table>	样品编号 Sample No.	最高温度 (°C) Maximum Temperature	判定: 是否符合要求 Verdict	—	—	—	—	—	—	—	—	—	—	—	—	—	—	—	
样品编号 Sample No.	最高温度 (°C) Maximum Temperature	判定: 是否符合要求 Verdict																	
—	—	—																	
—	—	—																	
—	—	—																	
—	—	—																	
—	—	—																	

UN 38.3 测试方法、数据及结果 Test method and data

<p>38.3.4.7 试验 T.7: 过度充电 Test T.7: Overcharge</p> <p>38.3.4.7.1 目的 本试验评估可充电锂离子电池组或单体电池可充电电池组承受过度充电状况的能力。</p> <p>38.3.4.7.2 试验程序 充电电流必须是制造商建议的最大连续充电电流的两倍。试验的最小电压应为如下： (a) 制造商建议的充电电压不大于 18 伏时，试验的最小电压应是电池组最大充电电压的两倍或 22 伏两者中的较小者。 (b) 制造商建议的充电电压大于 18 伏时，试验的最小电压应为最大充电电压的 1.2 倍。 试验应在环境温度下进行。进行试验的时间应为 24 小时。</p> <p>38.3.4.7.3 要求 充电电池组如在进行过程中和试验后 7 天内无解体，无起火，即符合本项要求。</p> <p>38.3.4.7.1 Purpose This test evaluates the ability of a rechargeable battery or a single cell rechargeable battery to withstand an overcharge condition.</p> <p>38.3.4.7.2 Test procedure The charge current shall be twice the manufacturer's recommended maximum continuous charge current. The minimum voltage of the test shall be as follows: (a) when the manufacturer's recommended charge voltage is not more than 18V, the minimum voltage of the test shall be the lesser of two times the maximum charge voltage of the battery or 22V. (b) when the manufacturer's recommended charge voltage is more than 18V, the minimum voltage of the test shall be 1.2 times the maximum charge voltage. Tests are to be conducted at ambient temperature. The duration of the test shall be 24 hours.</p> <p>38.3.4.7.3 Requirement Rechargeable batteries meet this requirement if there is no dis assembly and no fire within seven days of the test.</p>	<p>P</p>																		
<table border="1" style="width: 100%; border-collapse: collapse;"> <thead> <tr> <th style="width: 20%; text-align: center;">样品编号 Sample No.</th> <th style="text-align: center;">判定：是否符合要求 Verdict</th> </tr> </thead> <tbody> <tr><td style="text-align: center;">A11</td><td style="text-align: center;">P</td></tr> <tr><td style="text-align: center;">A12</td><td style="text-align: center;">P</td></tr> <tr><td style="text-align: center;">A13</td><td style="text-align: center;">P</td></tr> <tr><td style="text-align: center;">A14</td><td style="text-align: center;">P</td></tr> <tr><td style="text-align: center;">B1</td><td style="text-align: center;">P</td></tr> <tr><td style="text-align: center;">B2</td><td style="text-align: center;">P</td></tr> <tr><td style="text-align: center;">B3</td><td style="text-align: center;">P</td></tr> <tr><td style="text-align: center;">B4</td><td style="text-align: center;">P</td></tr> </tbody> </table>	样品编号 Sample No.	判定：是否符合要求 Verdict	A11	P	A12	P	A13	P	A14	P	B1	P	B2	P	B3	P	B4	P	
样品编号 Sample No.	判定：是否符合要求 Verdict																		
A11	P																		
A12	P																		
A13	P																		
A14	P																		
B1	P																		
B2	P																		
B3	P																		
B4	P																		

UN 38.3 测试方法、数据及结果 Test method and data

38.3.4.8 试验 T.8: 强制放电 Test T.8: Forced discharge	P
--	---

38.3.4.8.1 目的
 本试验评估原电池或充电电池承受强制放电状况的能力。

38.3.4.8.2 试验程序
 每个电池必须在环境温度下与 12 伏的直流电电源串联在起始电流等于制造商给定的最大放电电流的条件下强制放电。
 将适当大小和额定值的电阻负荷与试验电池串联，计算得出给定的放电电流。对每个电池进行强制放电，放电的时间（小时）应等于其额定容量除以初始试验电流（安培）。

38.3.4.8.3 要求
 原电池或充电电池如在试验过程中和试验后 7 天内无解体，无起火，即符合本项要求。

38.3.4.8.1 Purpose
 This test evaluates the ability of a primary or a rechargeable cell to withstand a forced discharge condition.

38.3.4.8.2 Test procedure
 Each cell shall be forced discharged at ambient temperature by connecting it in series with a 12V D.C. power supply at an initial current equal to the maximum discharge current specified by the manufacturer.
 The specified discharge current is to be obtained by connecting a resistive load of the appropriate size and rating in series with the test cell. Each cell shall be forced discharged for a time interval (in hours) equal to its rated capacity divided by the initial test current (in ampere).

38.3.4.8.3 Requirement
 Primary or rechargeable cells meet this requirement if there is no dis assembly and no fire during the test and within seven days after the test.

样品编号 Sample No.	判定：是否符合要求 Verdict	样品编号 Sample No.	判定：是否符合要求 Verdict
D1	P	E1	P
D2	P	E2	P
D3	P	E3	P
D4	P	E4	P
D5	P	E5	P
D6	P	E6	P
D7	P	E7	P
D8	P	E8	P
D9	P	E9	P
D10	P	E10	P

样品照片 Photos of the sample

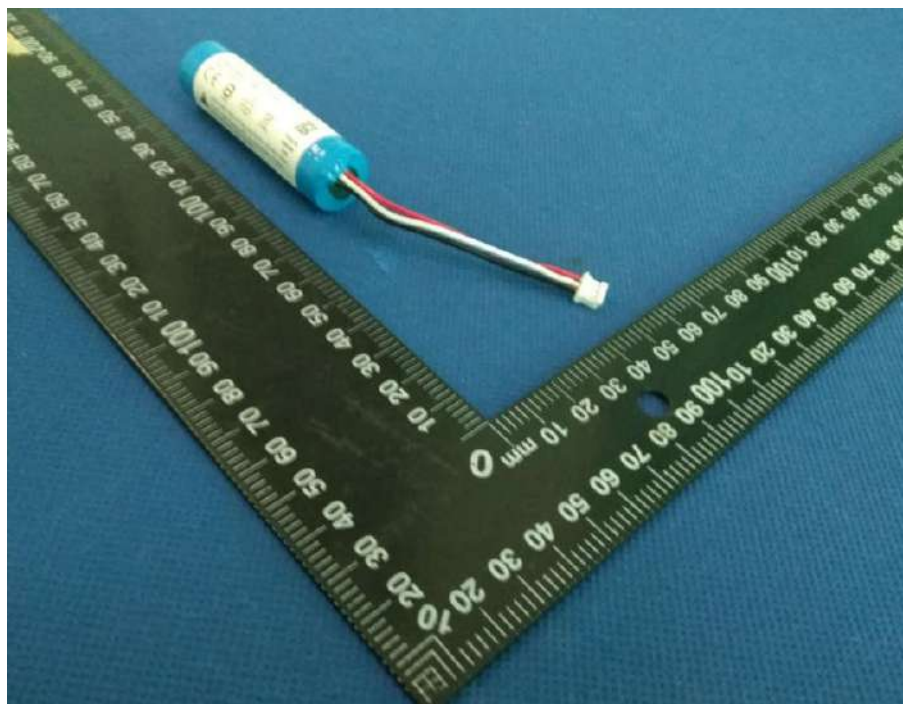

电池组外观
View of the battery

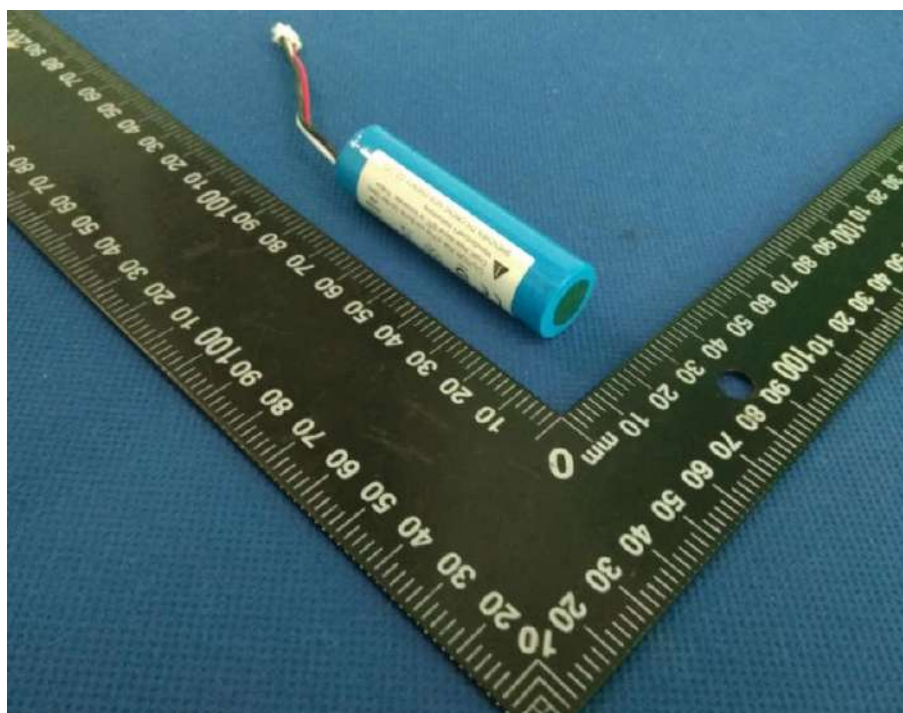

电池组外观
View of the battery

样品照片 Photos of the sample

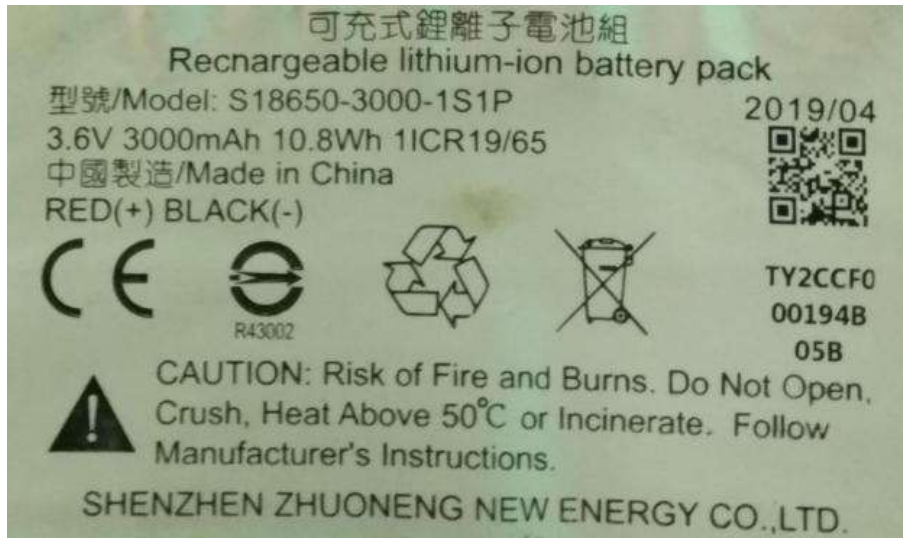

電池組銘牌
View of the battery nameplate



元件電池
View of the component cell

试验仪器设备清单

Test equipment list

序号 No.	名称 Name	型号 Type	编号 Equipment No.	校准有效期至 Calibration Date	本次使用 Used (√)
1.	振动试验台 Vibration Platform	DC-300-3	CIS1559-001	2020.04.18	√
2.	冲击试验台 Shock Platform	CL-50/KCL-2000	CIS1559-002	2020.04.18	√
3.	电池温控短路试验机 Battery short circuit by	BE-8102	CIS1737-034	2020.04.18	√
4.	电池低气压试验箱 Low Pressure Chamber	BE-8104	CIS1559-007	2020.04.18	√
5.	电池重物冲击试验机 Shock Testing Machine	BE-8106	CIS1737-036	2020.04.18	√
6.	快速温变试验箱 High-low Temperature Test Chamber	KWGD61	CIS1737-042	2020.04.18	√
7.	电池充放电测试仪 Battery Charge And Discharging Tester	HYNN-20V5A-GGS	CIS1737-043	2020.04.18	√
8.	电池充放电测试仪 Battery Charge And	HYNN-20V5A-GGS	CIS1737-044	2020.04.18	√
9.	数据采集仪 Data Collector	GL840	CIS1737-053	2020.04.18	√
10.	数字万用表 Digital multi meter	34461A	CIS165M-031	2020.04.18	√
11.	电子天平 Electronic balance	JJ224BC	CIS1737-033	2020.04.18	√
12.	多通道短路器 Multi channel short circuit	6×32A	CIS1559-026	2020.04.18	√

注意事项

NOTES

1. 本报告未加盖“试验报告专用章”无效；

This test report is invalid without testing stamp.

2. 本报告未经本实验室批准不得部分复印；

The test report shall not be reproduced except in full without the written approval of the Laboratory.

3. 本报告试验结果只对受试样品有效；

The test results presented in this report is only valid to the samples tested.

实验室地址(Address): 北京亦庄经济技术开发区同济南路 8 号

**No.8 TongJiNanLu, Yizhuang Economic&Technological
Development Area, Beijing, China**

邮政编码 (Zipcode) : 100176

电话(Telephone) : 010-64102186

传真(Fax) : 010-64102185

网址(Website) : WWW.CESL.CN