

Max.
20 MS/s
high-speed sampling

All analog channels
Max. **32 ch**
isolated

Logic channels
Max. **64 ch**
16 channels standard



For on-site work and R&D testing Global Standard Recorder

Measuring multi-channel voltage and current simultaneously

4CH ANALOG UNIT

3CH CURRENT UNIT

Compatible with multi-channel input units (Ver. 2.00 or later)

High-voltage 1000 V direct input measurement

HIGH-VOLTAGE UNIT

Max. 1 MS/s high-speed sampling, 16-bit resolution measurement

Generate and record in a single unit

ARBITRARY WAVEFORM GENERATOR UNIT

Reproduce and output problematic waveform measurements

No amp needed; max. 15 V output



Testing



Vibration testing at the product development stage

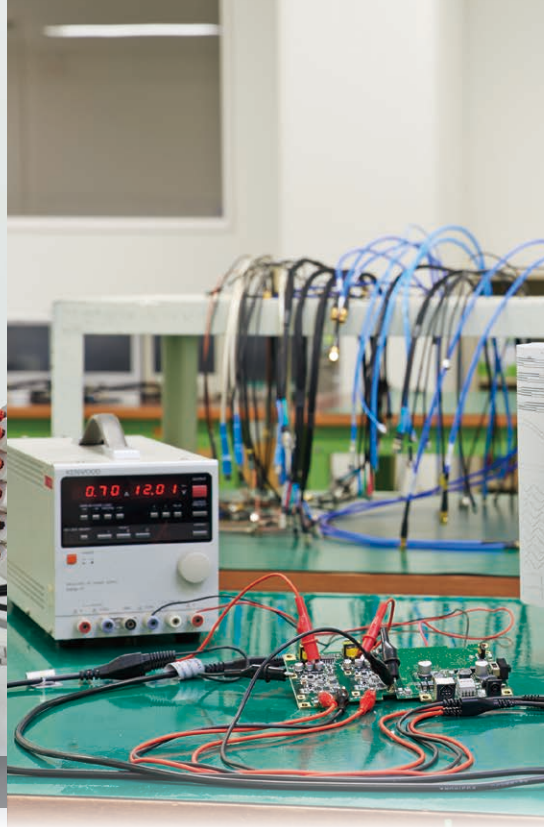

A high-spec, high-quality versatile measuring device

20 MS/sec sampling speed

Perform multi-channel, high-speed sampling at 20 M samples/sec (time axis resolution: 50 nsec) for all channels at the same time.

Note: when U8975, U8977 or U8978 are installed, max. sampling speed is 10 MS/second

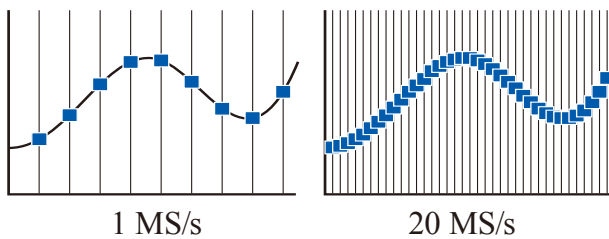

High-speed sampling allows you to measure the rising edge of pulses and detect anomaly operations and instantaneous waveforms that occur suddenly with high precision.

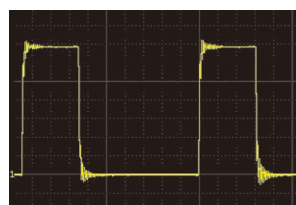

Observe the rising edge of pulses

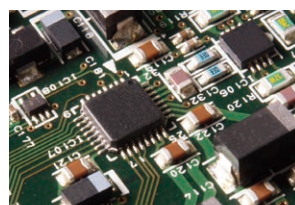

Input amp with built-in A/D converter

Isolated input for all channels

Connections between analog input channels, and between the input channel and the main unit, are isolated by isolation elements. So potential differences can be measured without any concerns, unlike with an oscilloscope.

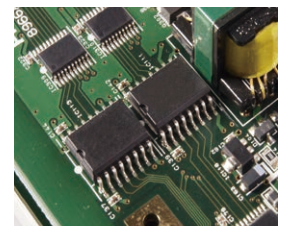

Isolation element

A4 size built-in printer

Print large, high-definition hard copies for easy on-site checking. Paper is easy to replace by inserting a new roll, rolling out the paper slightly, and then closing the cover.



Simply open the cover, insert the new paper, and then close the cover

Development

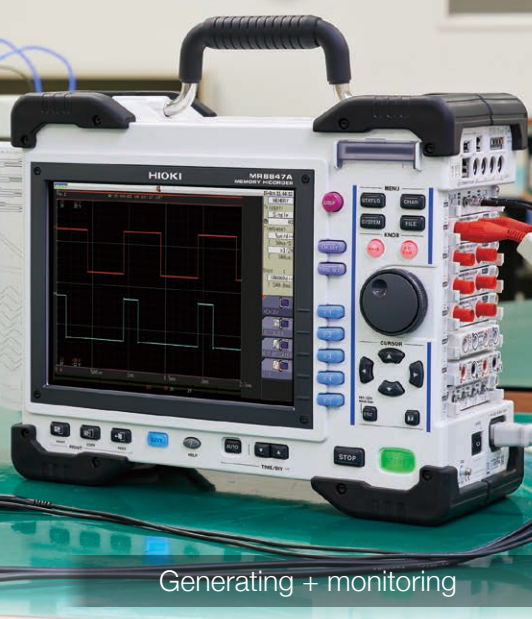

Generating + monitoring

Surveys



Power supply surveys for power equipment

Abundant modules

Hioki has added new high-performance modules in response to overwhelming demand. The Memory HiCorder now supports a wide variety of measurements.

- NEW** 4ch ANALOG UNIT U8975
- NEW** 4CH ANALOG UNIT U8978
- NEW** 3CH CURRENT UNIT U8977

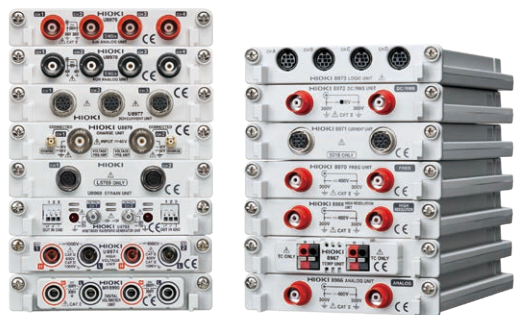

Up to 32 channels of analog waveforms

Add eight 4CH Analog Input Units to record a total of 32 channels at once. 100 V AC, up to 200 V DC, and outputs from various sensors can be recorded simultaneously for efficient measurement.

64 logic input channels

The MR8847A has 16 built-in logic input channels. Add 3 logic input units to record a total of 64 channels at once. The waveforms of all channels can be displayed on a single screen, making it ideal for timing measurements.

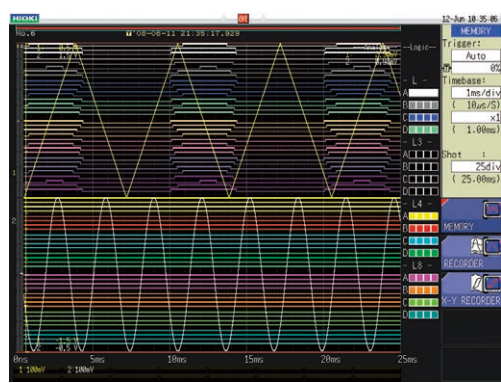

Measure and display multiple relays at the same time

Large 512 MW capacity (MR8847-53 only)

Hioki has developed an internal storage FPGA for super-high-speed access. Used in combination with large capacity high-speed memory, this enables many hours of high-speed sampling to be recorded.

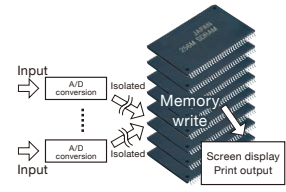

NEW SSD 128 GB storage media

The new internal SSD unit (available as an additional option) has 128 GB of capacity, allowing large amounts of data to be stored.



Durable design, with resistance to dropping up to 50 cm (19.69 in.)

The MR8847A is resistant to strong mechanical shock and vibration, such as short drops. The durable design has been tested to withstand vertical drops of up to 50 cm (19.69 in.).



* Tested based on in-house conditions. A dropped unit is not guaranteed to be free of damage or trouble.



An Extensive Line of Units for Detecting a Wide Range of Phenomena

Combine multiple units to record a range of phenomena simultaneously. For example, use five *4CH Analog Units* to measure 20 analog channels and three *Logic Units* to measure up to 64 channels relay on/off signals or PLC (programmable logic controller) signals. That's simultaneous measurement of 84 channels!



4 ch
200 V DC

Simultaneously measure up to 32 channels

NEW 4CH Analog Unit U8975

The U8975 accepts direct input of up to 200 V DC across 4 channels. With a sampling rate of 5 MHz (across a frequency band of 2 MHz), high speed, and 16-bit resolution, it can perform multi-channel, high-speed, and high-resolution measurement.

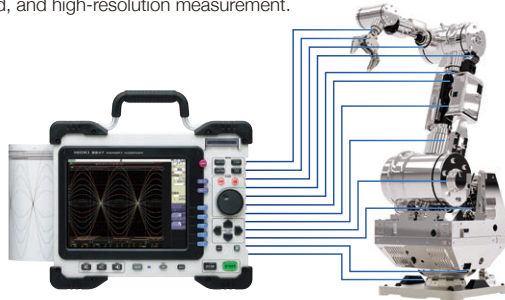

Simultaneous measurement of multiple locations across 32 channels at 5 MS/s



4 ch
100 mV f.s.

Simultaneously measure up to 32 channels at high resolution

NEW 4CH Analog Unit U8978

Thanks to four input channels and a high-sensitivity 100 mV f.s. range, the U8978 can measure multiple channels of output from a variety of sensors. The unit is ideal for use in measuring currents of various magnitudes in the development of automobile accessory controls. Utilized in combination with the multi-range Current Probe CT6711, it can measure currents from 1 mA to 50 A.

Observe minuscule currents using high-sensitivity wideband current probes

Current probe lineup

Analyze minuscule current waveforms from low-power-consumption devices in 100 μ A resolution. Record device current consumption waveforms in high resolution over extended periods of time.



Current consumption waveform for a temperature and humidity sensor

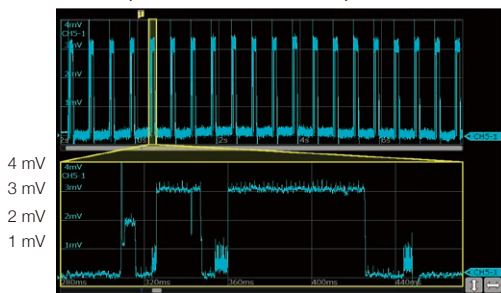

During measurement with the CT6711 (10 V/A range) Elapsed time [ms]



700 V AC
1000 V DC

Direct, high-voltage input without differential probes High Voltage Unit U8974

The U8974 is ideal for measuring the primary and secondary sides of UPS power supplies and commercial power supply transformers. It can measure high-voltage power lines, including 380 V and 480 V circuits found in many countries. With high-speed sampling at up to 1 MS/s and 16-bit resolution, it can also be used in load rejection testing and switch testing.

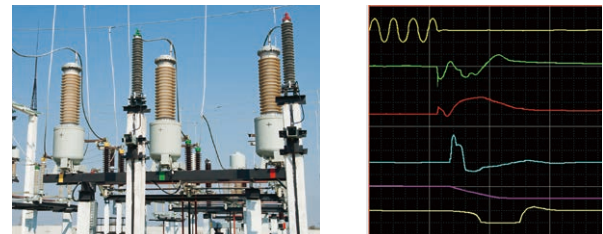

Analyze correlations between phenomena, including voltage levels before and after generator disconnection, RPM fluctuation rates, governor servo operating status, and voltage governor switching timing.



Maximum resolution
0.1 μ V

Specifically designed for DC voltage measurement with extremely high precision and resolution Digital Voltmeter Unit MR8990

The MR8990 can measure minuscule fluctuations in sensor output of automobiles and voltage fluctuations in batteries, both at high precision and resolution. It can accommodate maximum input of 500 V DC. The unit is distinguished by its high input resistance. Additionally, the amount of space taken up by instruments can be reduced by replacing a bench-style DMM with the MR8847A. Systems can be simplified by eliminating the need to control multiple instruments.

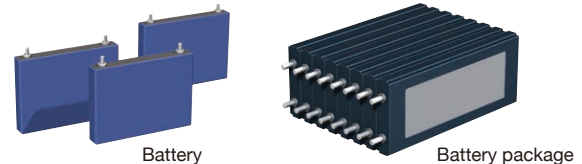

Measurement range	Effective input range (Guaranteed measurement accuracy range)	Max. resolution	Input resistance	Measurement accuracy	
				NPLC: less than 1	NPLC: 1 or more
5 mV/div (f.s. = 100 mV)	-120 mV to 120 mV	0.1 μ V	100 M Ω or more	$\pm 0.01\%$ rdg. $\pm 0.015\%$ f.s.	$\pm 0.01\%$ rdg. $\pm 0.01\%$ f.s.
50 mV/div (f.s. = 1000 mV)	-1200 mV to 1200 mV	1 μ V		$\pm 0.01\%$ rdg. $\pm 0.0025\%$ f.s.	
500 mV/div (f.s. = 10 V)	-12 V to 12 V	10 μ V	10 M Ω $\pm 5\%$	$\pm 0.025\%$ rdg. $\pm 0.0025\%$ f.s.	
5 V/div (f.s. = 100 V)	-120 V to 120 V	100 μ V			
50 V/div (f.s. = 1000 V)	-500 V to 500 V	1 mV			

● 6.5-digit display (resolution: 0.1 μ V), 24-bit high resolution



**3 ch
5 MS/s**

Single solution for 3-phase current measurement

NEW 3CH Current Unit U8977

The U8977 delivers a sampling rate of 5 MS/s, frequency characteristics of 2 MHz, 16-bit A/D resolution, and DC accuracy of 0.3% f.s. to facilitate wideband, high-precision current measurement using Hioki current sensors.

Automatic configuration of sensor scaling values

When you connect a current sensor, the MR6000 will automatically detect the model and set the appropriate scaling value.

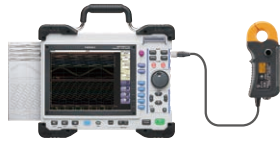

Connect sensors directly

Power is supplied from the current unit

Since current sensor power is supplied directly from the current unit, there's no need to provide a sensor power supply.



Compatible with high-precision sensors for measuring large currents

Current sensor lineup

Clamp-type high-accuracy sensors deliver excellent temperature characteristics, allowing highly accurate measurements to be made even in the confined space of a vehicle's engine compartment.



Sensitivity variations of high-accuracy clamp-type sensors caused by temperature

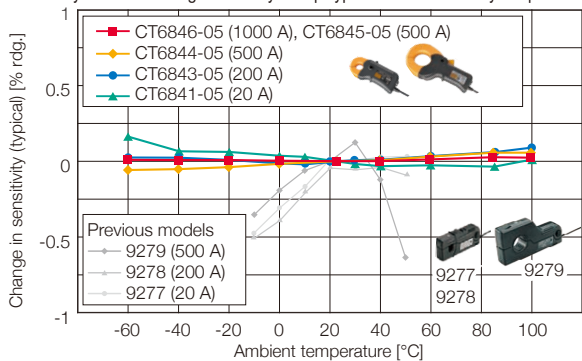

Zero-point stability

Wideband flux gate technology delivers high zero-point stability over extended periods of time.

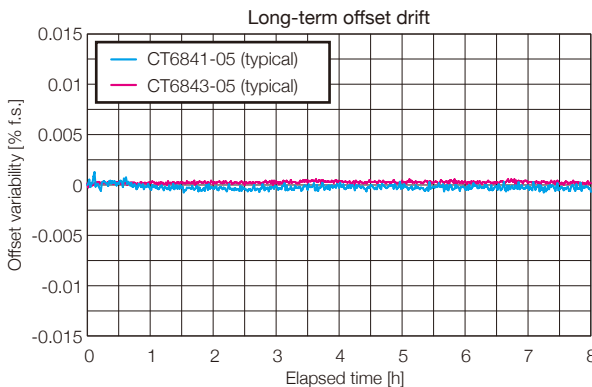

Hioki offers a wide range of current sensors to suit all frequency band and rated current needs



**2 ch
SMB terminals**

Generate and record in a single unit

Arbitrary Waveform Generator Unit U8793

2 channels, SMB terminals
2 types of output cables (sold separately)



Just one MEMORY HiCORDER gives you a function generator mode, arbitrary waveform generator mode, and waveform measurement mode. This makes it easy to observe waveforms while varying test conditions, such as changing the signal's amplitude and frequency and programming various waveforms to output in order.

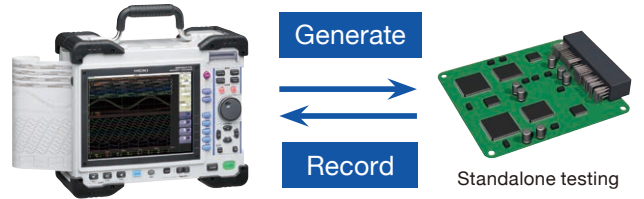

Output recorded waveforms without modification

For example, you could output actual waveforms recorded from a car without modification, and then use them for standalone testing. You can also generate isolated output of up to 15 V without a generator or amplifier, which is traditionally necessary in order to generate output while varying the signal's amplitude and frequency.



Process actual waveforms for reproducibility testing

Process and calculate signals recorded with the MEMORY HiCORDER and output the arbitrary waveforms that you create.

Waveform Maker Software included

After you install the included SF8000 Waveform Maker software on your computer, you can create waveforms easily by either entering them directly or by entering the functions behind them. You can also quickly add noise and multiply waveforms.

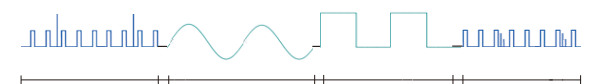
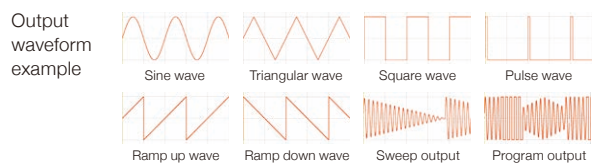
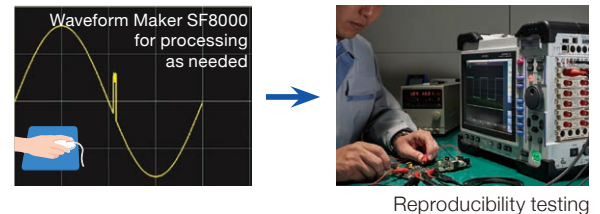

Program and generate connected waveforms

The right unit for your measurement needs

2 ch
voltage
measurement

Inverter/UPS test

Perfect for inverter and UPS evaluation/start-up tests.

Record using both logic (control signals) and analog (primary/secondary voltage or current for a UPS or inverter).

- Operation testing and evaluation during load fluctuation
- Confirmation of UPS switching

Device	Model no.	Units
MEMORY HiCORDER	MR8847-51	1 unit
ANALOG UNIT	8966	1
CONNECTION CORD	L9198	2
CURRENT UNIT	8971	1
CLAMP ON SENSOR	9272-05	1
CONVERSION CABLE	CT9901	1
LOGIC PROBE	9327	1



UPS



Inverter

4 ch
voltage
measurement

4 ch
current
measurement

Power electronics

A differential probe and a high-precision current sensor support broadband power electronics measurements. Frequency analysis using FFT is also available.

- Transient response measurement of motors
- Long-term stability measurement by recorder function

Device	Model no.	Units
MEMORY HiCORDER	MR8847-51	1 unit
4CH ANALOG UNIT	U8978	1
DIFFERENTIAL PROBE	9322	4
AC ADAPTER	9418-15	4
3CH CURRENT UNIT	U8977	2
AC/DC CURRENT SENSOR	CT6875	4

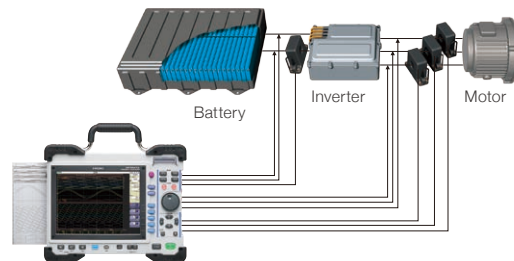

5 ch
voltage
measurement

1 ch
current
measurement

Transformer dump tests

Interchannel isolation allows for safe circuit connections. Simultaneous high-speed sampling can record waveforms before and after the dump. Input large numbers of control and circuit signals.

- The correlation between the voltage before and after the interruption of a generator
- RPM fluctuation rate
- Governor servo motor operation conditions
- Suppression machine switch timing

Device	Model no.	Units
MEMORY HiCORDER	MR8847-51	1 unit
HIGH-VOLTAGE UNIT	U8974	1
4CH ANALOG UNIT	U8975	1
FREQ UNIT	8970	1
CONNECTION CORD	L9197	5
CURRENT UNIT	8971	1
CLAMP ON SENSOR	9272-05	1
CONVERSION CABLE	CT9901	1
LOGIC PROBE	9320-01	1

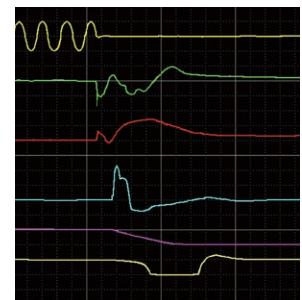

Maximum 1 MS/s high-speed sampling and 16-bit resolution in the high-voltage unit allow the MR8847A to be used for interruption and switch testing

4 ch waveform output
4 ch voltage measurement

Anomaly simulation testing

Reproduce and output the observed anomalous waveforms without modification. When resolving problems observed during research or development, you can reproduce such problems for efficient testing. You can also output waveforms that you created yourself for testing and measure the results at the same time.

- Generate simulated output of each type of sensor signal
- Fluctuating simulated output for 12 V CD car batteries

Device	Model no.	Units
MEMORY HiCORDER	MR8847-51	1 unit
4CH ANALOG UNIT	U8978	1
ARBITRARY WAVEFORM GENERATOR UNIT	U8793	2
CONNECTION CORD	L9198	4

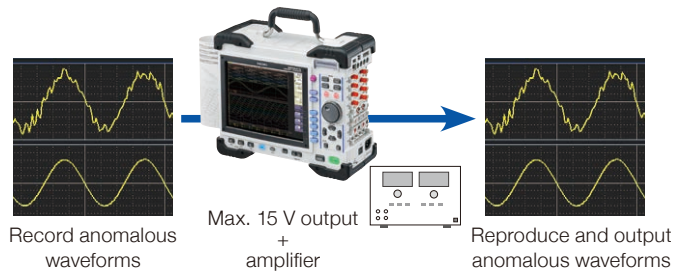

4 ch strain measurement
2 ch vibration measurement

Vibration/endurance tests

512 MW of high-capacity memory makes it easy to observe vibration waveforms for many hours while performing high-speed sampling. This feature is perfect for detecting waveform peaks.

- Analyze the relationship between engine control and vibration
- Confirm equipment durability

Device	Model no.	Units
MEMORY HiCORDER	MR8847-53	1 unit
4CG ANALOG UNIT	U8978	1
STRAIN UNIT	U8969	2
CHARGE UNIT	U8979	1

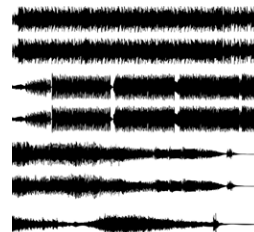

Observe minor vibrations with high precision



Vibration testing equipment

16 ch voltage measurement

Replace multiple DMMs with a single Memory HiCorder

Save space by replacing multiple desktop DMM units with a single MEMORY HiCORDER. This eliminates the need to control multiple units and simplifies your system.

- Minute fluctuations in sensor output for automobiles
- Voltage fluctuations in batteries

Device	Model no.	Units
MEMORY HiCORDER	MR8847-51	1 unit
DIGITAL VOLTAGE METER UNIT	U8990	8



Install up to 8 DVM units to expand up to 16 channels

Full range of supporting functions

On-site assistance

Help function

Understand operation methods without even reading the instruction manual using the built-in help function. Place the cursor on a field in the settings and press the HELP button to view a detailed description of that setting.



Press the "HELP" button

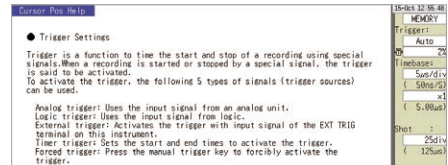

A detailed description of the setting is displayed

Master triggers

Set triggers while viewing waveforms

Set input triggers while checking waveforms. You can also display the settings screen separately as a floating screen.

Trigger functions for monitoring all measurement channels

- Level trigger for comparing a single voltage value
- Window trigger for comparing 2 voltage values
- Voltage drop trigger for detecting voltage drops in commercial power lines
- Period trigger for monitoring periods
- Glitch trigger for detecting anomalies in pulses
- Pattern trigger for comparisons when the logic signal is on/off

Acquiring data with triggers, and post-acquisition searching

The MR8847A includes a search function for finding abnormal waveforms within all of the acquired data. You can use this function to search for anomalies after data has been acquired, when it is too difficult to set triggers because it is not possible to predict what types of anomalies might be observed.

Set the number of events for each source

* Only for level and glitch triggers

Set trigger conditions in a variety of combinations.

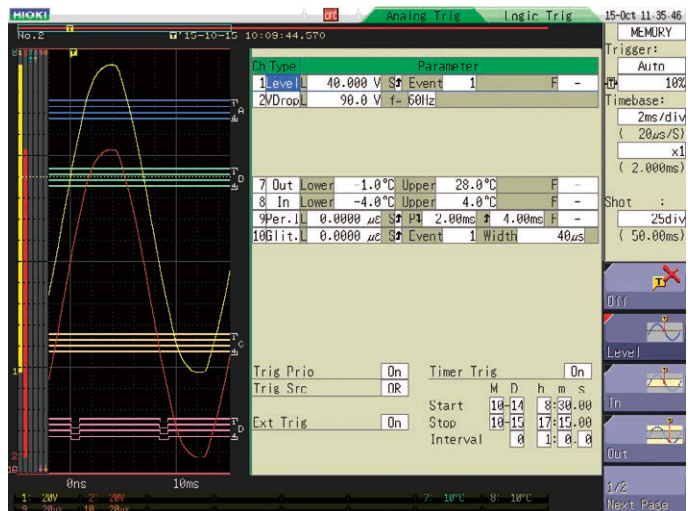

Adjust levels while displaying waveforms

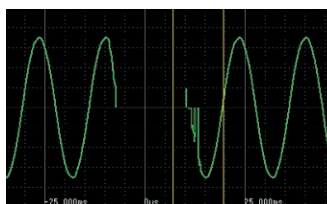

Detect instantaneous outages



Setting screen for number of events

Label each channel

Comment entry function

Set comments for each channel and display them on the screen, even when observing multiple channels, making identification easy.

Comments can be entered directly on the main unit. And when printing, you can also print the channel comments.

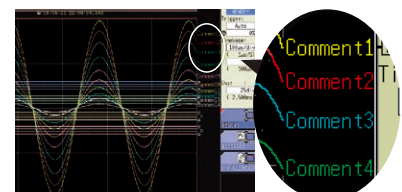
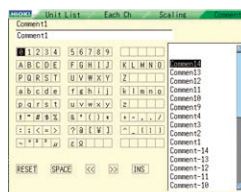

Enlarge waveforms

Zoom function

Display time axis reduced waveforms at the top of the screen, and time axis enlarged waveforms at the bottom of the screen. You can use the scroll function to display the entire waveform while also observing specific parts.

Collapse waveform



Check the entire waveform

Expand waveform



Enlarge/shrink along the time/vertical axes

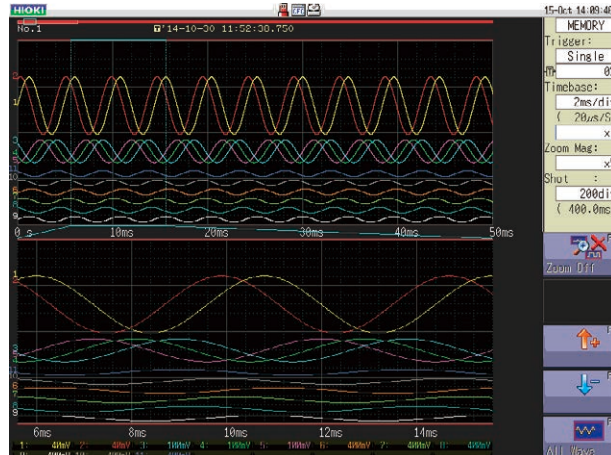

Enlarge to observe waveform details

Scan and clip

AB cursor function

Apply the Zoom function to set point A and point B for the area you want to clip.

Scan



Scan data at the cursor and the waveform's cross point

Extract



Specify the segment to save as binary or CSV data

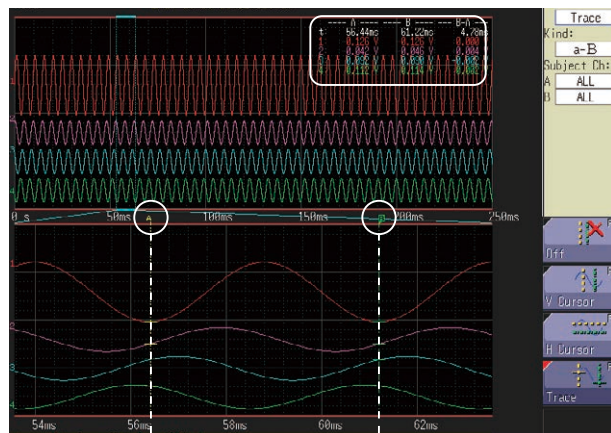

Conveniently manage scanned data on your computer

PC operations

Connect to LAN for HTTP/FTP server functions

Use the HTTP function to operate the MEMORY HiCORDER with a browser on a PC connected via LAN. You can also use the FTP function to acquire data from the internal memory or from storage media inserted in the MEMORY HiCORDER.

You can even acquire data from the internal memory or from storage media connected to the MEMORY HiCORDER via USB.

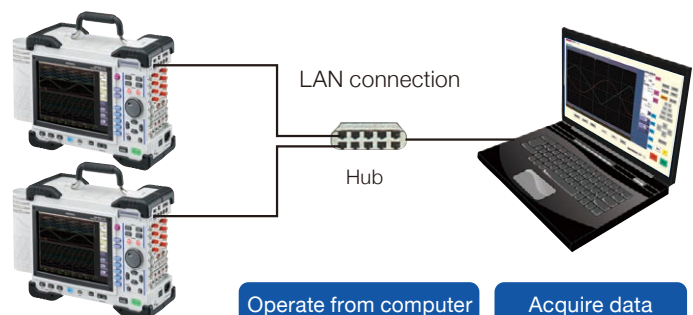

Record the data you need

Simultaneous recording on storage media

*When sampling at low speed of 100 msec/div or less

Memory functions

Recording method Sampling is done at the user-set period, and all data is recorded

- Automatic data saving on SSD/CF card or USB memory stick
- During high-speed sampling, data is written to internal memory first and later saved on other media
- During low-speed sampling, data is written to internal memory while also saved on other media
- Effective in reducing the dead time between measurements

Maximum recording time to internal memory (excerpt)

		MR8847-51 (64 MW)	MR8847-52 (256 MW)	MR8847-53 (512 MW)
Maximum recording length fluctuates depending on number of channels used.		16 analog channels + 16 internal logic channels	16 analog channels + 16 internal logic channels	16 analog channels + 16 internal logic channels
Time axis	Sampling period	40,000 divisions	160,000 divisions	320,000 divisions
5 μs/div	50 ns	0.2 s	0.8 s	1.6 s
10 μs/div	100 ns	0.4 s	1.6 s	3.2 s
100 μs/div	1 μs	4 s	16 s	32 s
1 ms/div	10 μs	40 s	2 min 40 s	5 min 20 s
100 ms/div	1 ms	1 h 06 min 40 s	4 h 26 min 40 s	8 h 53 min 20 s
1 s/div	10 ms	11 h 06 min 40 s	1 d 20 h 26 min 40 s	3 d 16 h 53 min 20 s
1 min/div	600 ms	27 d 18 h 40 min 00 s	111 d 02 h 40 min 00 s	222 d 05 h 20 min 00 s
5 min/div	3.0 s	138 d 21 h 20 min 00 s	555 d 13 h 20 min 00 s	1111 d 02 h 40 min 00 s

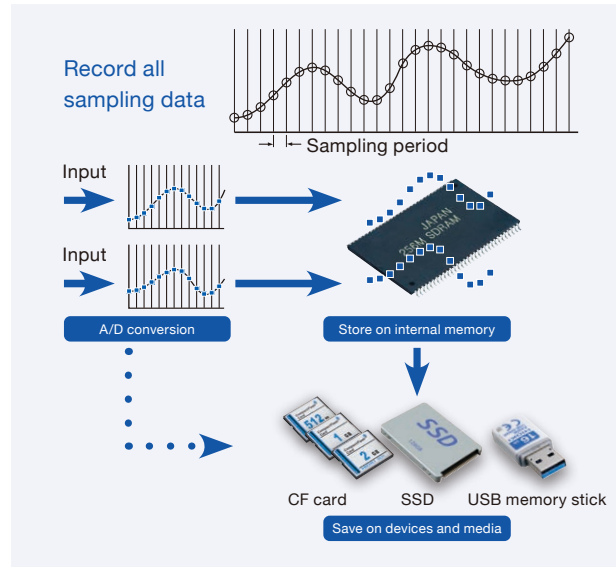

- Caution: available recording duration is determined by internal RAM capacity, not by external media
- Caution: for more reliable data protection, we recommend use of Hioki CF cards or USB DRIVE Z4006, which are guaranteed to work with the instrument
- Note: table shows maximum values at arbitrary recording length settings
- When measuring at sampling speed of 100 msec/div (1 msec sampling) or slower, data can be saved to media while measuring

Analysis software

WAVE PROCESSOR 9335

(software sold separately)

- Waveform display, calculations
- Print function

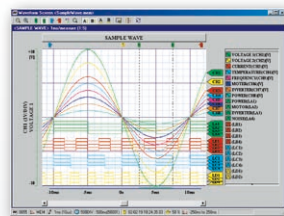

9335 brief specifications

Operating environment	Windows 10/8/7 (32-/64-bit)
Functions	- Display functions: waveform display, X-Y display, cursor function, etc. - File loading: readable data formats (.MEM, .REC, .RMS, .POW)/ maximum loadable file size: maximum file size that can be saved by a given device (file size may be limited depending on the computer configuration) - Data conversion: conversion to CSV format, batch conversion of multiple files, etc.
Printing	- Print function: printing image file output (expanded META type, ".EMF") - Print formatting: not divided; divided by 2, 4, 8, or 16; 2, 4, 8 or 16 columns; X-Y1, X-Y2 or X-Y4 screen, preview, hard copy

LAN COMMUNICATOR 9333

(software sold separately)

- Auto-save waveform data to PC
- Remote control via LAN connection
- Save in CSV format and transfer to spreadsheet programs

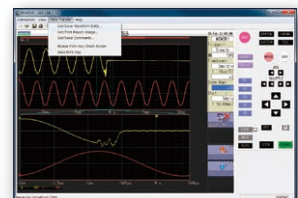

9333 brief specifications

Operating environment	Windows 10/8/7 (32-/64-bit), Vista (32-bit), XP, (9333 ver.1.09 or later)
Functions	- Auto-saves waveform data to PC, remote control of Memory HiCorder (by sending key codes and receiving images on screen), print report, print images from the screen, receive waveform data in the same format as waveform files from the Memory HiCorder (binary only) - Waveform data acquisition: accept auto-saves from the Memory HiCorder, same format as auto-save files of the Memory HiCorder (binary only), print automatically with a Memory HiCorder from a PC. The Memory HiCorder's print key launches printouts on the PC - Waveform viewer: simple display of waveform files, conversion to CSV format, etc.

Chart recording without missing transient events

Recorder functions

Recording method Sampling is done at the user-set period, and data other than the maximum and minimum values is thinned out for recording

- High-speed sampling ensures that transient events are captured even with slow recording
- Data compression achieved by recording maximum/minimum value pairs
- Max. 833-day (1 hr/div) long-term recording even for 64 MW model
- Continuous recording until paper runs out for chart output

Maximum recording time with the recorder function

REC time axis	Sampling period	To internal memory 20,000 divisions	Continuous (approx. recording time with 30 m paper roll) * Calculated as 30 m = 2970 divisions * Changing paper enables semi-permanent continuation of recording	
100 ms/div	* Limited by combination of selections under 1/100 on time axis and time axis setting for memory recording	33 min 20 s	Display only	
200 ms/div		1 h 6 min 40 s	Display only	
500 ms/div		2 h 46 min 40 s	24 min 45 s	
1 s/div		5 h 33 min 20 s	49 min 30 s	
2 s/div		11 h 6 min 40 s	1 h 39 min 00 s	
5 s/div		1 d 3 h 46 min 40 s	4 h 7 min 30 s	
10 s/div		100 ms	2 d 7 h 33 min 20 s	8 h 15 min 00 s
30 s/div		100 μs	6 d 22 h 40 min 00 s	24 h 45 min 00 s
50 s/div		10 μs	11 d 13 h 46 min 40 s	1 d 17 h 15 min 00 s
100 s/div		1 ms	23 d 3 h 33 min 20 s	3 d 10 h 30 min 00 s
1 min/div		10 ms	13 d 21 h 20 min 00 s	2 d 1 h 30 min 00 s
2 min/div		100 μs	27 d 18 h 40 min 00 s	4 d 3 h 00 min 00 s
5 min/div		1 ms	69 d 10 h 40 min 00 s	10 d 7 h 30 min 00 s
10 min/div		10 ms	138 d 21 h 20 min 00 s	20 d 15 h 00 min 00 s
30 min/div		100 μs	416 d 16 h 00 min 00 s	61 d 21 h 00 min 00 s
1 hr/div		1 ms	833 d 8 h 00 min 00 s	123 d 18 h 00 min 00 s

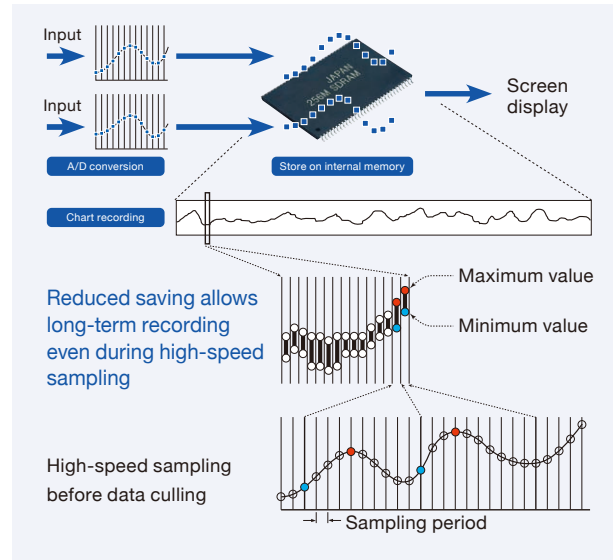

Notes

- When opening data created with the recorder function on a computer, the maximum and minimum data pairs are lined up in a time series.
- Length of printer paper roll is 30 meters. Paper can be changed during operation without stopping the recording process.
- With settings between 100 and 200 ms/div on the time axis, continuous recording is not possible if the printer is on.
- The table shows values for the MR8847-51 (64 M-words memory capacity). Model MR8847-52 (256 MW) can record four times and Model MR8847-53 (512 MW) eight times as much. On the "Continuous" setting in recording length, total recording time cannot be increased.

iPad App for Memory HiCorder HMR Terminal

Free app (exclusively for iPad) downloadable from the App Store

- Freely control waveforms using iPad's gesture controls
- Fingertip operation of max. 32 channels of waveform data
- Operate the Memory HiCorder via network
You can change settings, and monitor waveforms during measurement.



■ Data can be viewed by the iPad using Hioki's dedicated apps available from the App Store. Search for "HIOKI" and download the "HMR Terminal" app.



*iOS is a registered trademark of Cisco Technology, Inc. and/or its affiliates in the United States and certain other countries.
*iPhone, iPad, iPad mini, iPad Pro and iPod touch are trademarks of Apple Inc.
*Apple and the Apple logo are trademarks of Apple Inc. App Store is a service mark of Apple Inc.
*Microsoft, Windows, Windows Vista, and Excel are either registered trademarks or trademarks of Microsoft Corporation in the United States and/or other countries.

■ HMR Terminal brief specifications (free software)

Operating environment	iOS on the iPad (Apple Inc.)
Functions	- Data acquisition: send to iPad via FTP using a WiFi router, or load to iPad via iTunes (PC app) - Intuitively operate waveform level searches, maximum/minimum/average values, zero position adjustment, and more at your fingertips - Waveform monitoring - Meter setting * Logic waveforms and computational waveforms are not supported

Wave Viewer Wv

(Bundled software)

- Check waveforms with binary data on a PC
- Save data in CSV format and transfer to spreadsheet programs

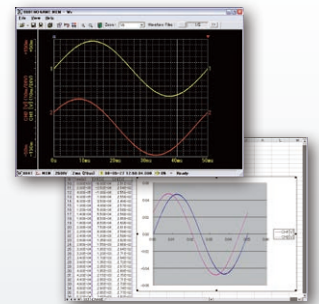

■ Wave Viewer (Wv) brief specifications

Operating environment	Windows 10/8/7 (32-/64-bit)
Functions	- Simple display of waveform files - Convert binary data files to text format, CSV, etc. - Scroll function, enlarge/reduce display, jump to cursor/trigger position, etc.

Definitive analysis of important data

Calculate parameter values from measured waveforms

The MR8847A can perform 24 calculations, including RMS, peak value, and maximum value, from measured waveforms. It can also perform time difference measurements, phase difference measurements, histogram measurements for high level and low level, and statistical processing. Calculation results are displayed together on the waveform observation screen.

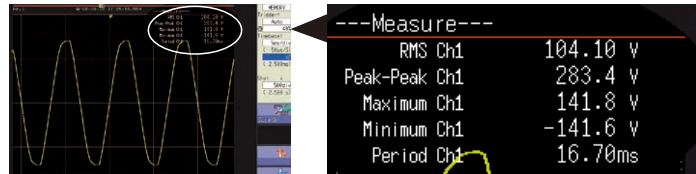

Process waveforms with formulas

If you know the required formulas, you can also perform more complicated calculations. By entering formulas, you can perform a variety of calculations even after measurements are complete. For example, you can make the settings shown on the right to find the RMS value from a measured waveform.

$$RMS = \sqrt{\frac{1}{n} \sum_{i=1}^n d_i^2}$$

RMS = RMS value
 n = data number
 di = data for channel i

Measure---
 RMS Ch2: 700.134mV
 Z1: 700.136m

— Measured waveform
 — Calculated waveform

Enter formula

Z1 = SQR(MOV(CH2*CH2,500))

Results are the same for both numerical calculations and waveform processing

FFT analysis function

The MR8847A can perform one-signal FFT for analyzing frequency components, two-signal FFT for analyzing transfer functions, and octave analysis for acoustics.

FFT calculations from memory waveforms

When performing FFT analysis of data measured with the memory function, you can use the jog shuttle to specify analysis points while also viewing the calculation results at the same time. You can also display both the raw data measured with the memory function and the calculation results for storage waveforms at the same time, which improves operability during analysis by displaying spectrum waveforms while checking the results of window functions.

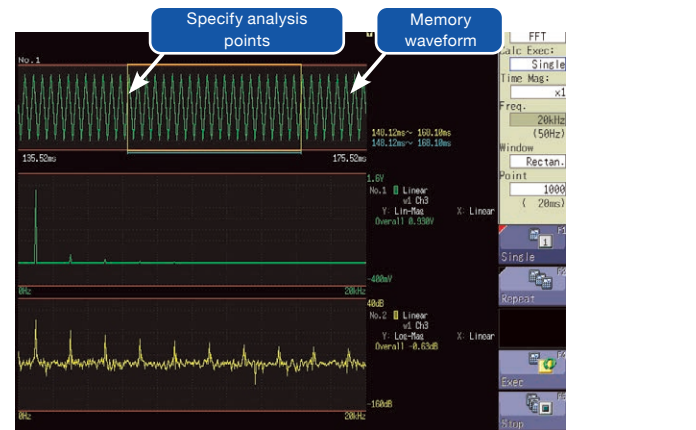

Display the calculation source (memory waveform) and FFT calculation results at the same time

Running spectrum display

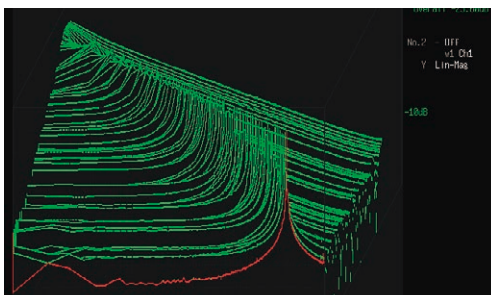

Display the spectrum as it changes over time in 3D

Change the number of calculation points after measurement

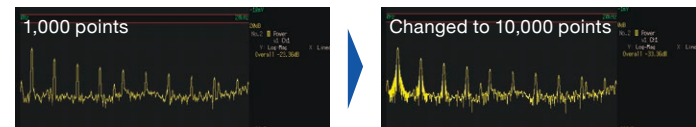

Scaling by "dB"

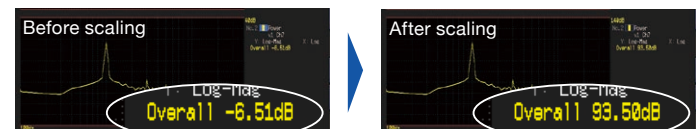

X-Y RECORDER

Now even easier to use with independent pen up/down control. Saving data in chronological order allows records to be saved as digital data, rather than paper hardcopies that need to be stored.

Pen up/down control

Pen up/down during X-Y recording is controlled independently. Press the function button or use an external control terminal (EXT. IN 1, 2, 3) for external control.

Replaces mechanical pen recorders

Use pen up/down control to record only the required data. This allows you to reduce the amount of unnecessary data that is recorded, and lower the running cost for paper.

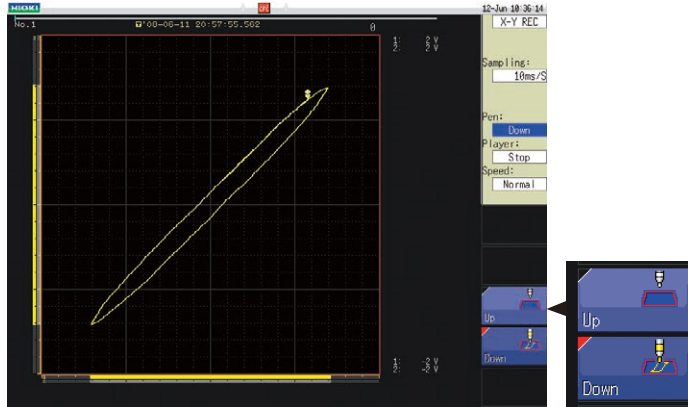

Pen up/down while recording X-Y waveforms



Control terminals

Determine waveform quality

Use the waveform judgment function, which monitors whether a waveform extends beyond the given area, to easily determine the quality of signal waveforms that are normally difficult to judge.

For time axis ranges that are slower than 100 msec/div, you can even make judgments while loading waveforms. This allows you to take the appropriate action the moment a poor waveform is detected on the production line. You can stop the line as soon as an abnormality is detected.

Judge FFT analysis waveforms

Judge FFT analysis waveforms in the same way.

Judge X-Y waveforms

In addition to time axis signals, the MR8847A also has a waveform judgment function for X-Y waveforms built in. Use this to detect:

- Displacement and pressure of presses
- Pressure and flow rate of pumps

The X-Y waveforms of the above and other data can be tested automatically based on area judgment.

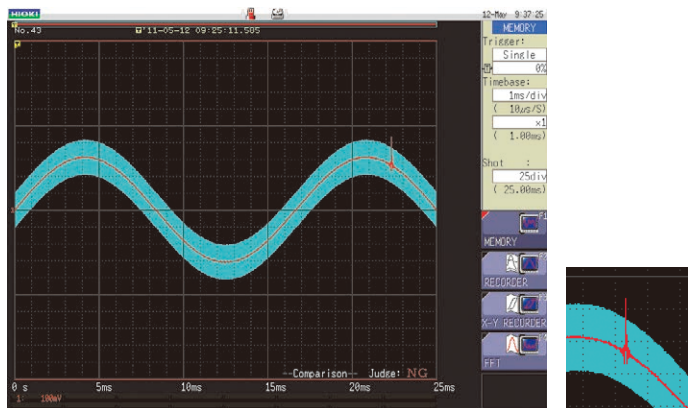

Judge waveform quality by area

Judgment: poor

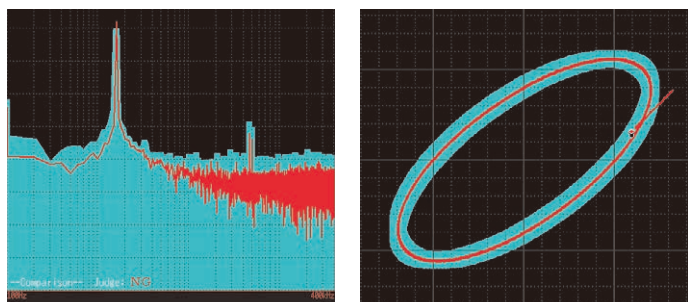

Judge FFT analysis waveforms and X-Y waveforms by area

Product specifications

Basic specifications <small>(Accuracy guaranteed for 1 year)</small>	
Measurement functions	MEMORY (high-speed recording), RECORDER (real-time recording) X-Y RECORDER, FFT
Example channel configurations/numbers	Eight analog input modules: 16 analog channels + 16 logic channels (built-in) Eight 4ch analog input modules: 32 analog channels + 16 logic channels (built-in) Five analog input modules + three logic input modules: 10 analog channels + 64 logic channels (16 built-in channels + 48 channels in logic input modules) Five 4ch analog input modules + three logic input modules: 20 analog channels + 64 logic channels (16 built-in channels + 48 channels in logic input modules) * For analog units, channels are isolated from each other and from frame GND. For logic units and internal standard logic terminals, all channels have a common ground.
Number of modules	Up to 8 modules Restrictions: Up to 4 modules of Model 8971 Current Unit can be installed Up to 3 modules of Model 8973 Logic Unit can be installed Up to 3 modules of Model U8977 3CH Current Unit
Number of the instrument logic channels	16 channels (the input connectors of logic channels share the ground with the instrument) * Installing Model MR8990 Digital Voltmeter Unit in both slots for unit 1 and unit 2 disables the instrument logic channels. * Restrictions imposed when the logic instrument channels are used (when the logic measurement is set to on) - Measurement resolution of each measuring module decreases to 12-bit when the module is installed in a slot for unit 1 or unit 2 - No frequency measuring modules are available when the module is installed in the slots for unit 1 or unit 2
Max. sampling speed	20 MS/second (50 ns period, all channels simultaneously) <i>Note: When U8975, U8977 or U8978 are installed, max. sampling speed is 10 MS/second</i> External sampling (10 MS/second, 100 ns period)
Memory capacity	MR8847-51: total 64 M-words (memory expansion: none) 32 MW/ch (using 2 analog channels), to 2 MW/ch (using 32 analog channels) MR8847-52: total 256 M-words (memory expansion: none) 128 MW/ch (using 2 analog channels), to 8 MW/ch (using 32 analog channels) MR8847-53: total 512 M-words (memory expansion: none) 256 MW/ch (using 2 analog channels), to 16 MW/ch (using 32 analog channels)
Removable storage	CF card slot (standard) × 1 (up to 2 GB, FAT, or FAT-32 format), SSD (128 GB, optional), USB memory stick (USB 2.0)
Backup function (At 25°C (77°F))	Clock and parameter setting backup: at least 10 years Waveform backup function: none
Control terminals	External trigger input, trigger output, external sampling input, two external outputs (GO, NG), three external inputs (START, STOP, PRINT)
External interface	LAN: 100BASE-TX (FTP server, HTTP server) USB: USB 2.0 compliant, series A receptacle × 1, series B receptacle × 1, (file transfer internal-drive/CF-card to PC, or remote control from PC)
Environmental conditions (no condensation)	Operation: -10°C to 40°C (14°F to 104°F), 20% to 80% RH With printer and/or SSD in use: 0°C to 40°C (32°F to 104°F), 20% to 80% RH Storage: -20°C to 50°C (-4°F to 122°F), 90% RH or less
Compliant standards	Safety: EN61010-1: 2010 EMC: EN61326-1:2003 Class A
Power supply	100 V AC to 240 V AC, 50/60 Hz 10 V DC to 28 V DC (using the DC POWER UNIT 9784: factory installation only)
Power consumption	130 VA max. (printer not used), 220 VA max. (printer used)
Dimensions and mass	Approx. 351 mm (13.82 in.) W × 261 mm (10.28 in.) H × 140 mm (5.51 in.) D, 7.6 kg (268.1 oz.) (main unit only)
Accessories	Instruction Manual × 1, Measurement Guide × 1, Application Disk (Waveform Maker Software SF8000, Wave Viewer Wv, communication commands table) × 1, power cord × 1, input cord label × 1, USB cable × 1, printer paper × 1, roll paper attachment × 2, ferrite clamp × 1
Product warranty period	3 years (for SSD unit U8331 is 1 year)
Display	
Display section	10.4 inch SVGA-TFT color LCD (800 × 600 dots) (time axis 25 div × voltage axis 20 div, X-Y waveform 20 div × 20 div)
Display languages	English, Japanese, Korean, Chinese
Waveform display zoom/compression	Time axis: × 10 to × 2 (zoom on MEMORY function only), × 1, × 1/2 to × 1/20,000 Voltage axis: × 100 to × 2, × 1, × 1/2 to × 1/10
Variable display	Upper/lower limit set, display/div set
Scaling	10:1 to 1000:1, automatic scaling for various probes Manual scaling (conversion ratio setting, 2-point setting, unit setting)
Comment entry	Alphanumeric input (title, analog and logic channels), simple input, history input, phrase input
Logic waveform	Display point move: 1% step, line width 3 types
Display partition	Max. 16 graphs
Monitor functions	- Level monitor - Numerical value (sampling 10 kS/s fixed, refresh rate 0.5 s)
Other display functions	- Waveform inversion (positive/negative) - Measurement cursor (A, B, 2-cursor, for all channels) - Vernier function (amplitude fine adjustment) - Zoom function (horizontal screen division, zoomed waveform shown in lower section) - 16 selectable colors for waveform display - Zero position shift in 1% steps for analog waveform - One-step zero adjustment for all channels and all ranges

Internal printer	
Features	Printer paper one-touch loading, high-speed thermal printing
Recording Paper	216 mm (8.50 in.) × 30 m (98.43 ft), thermal paper roll (use 9231 paper) Waveform section recording width: 200 mm (7.87 in.) 20 division full scale, 1 div = 10 mm (0.39 in.) 80 dots
Recording speed	Max. 50 mm (1.97 in.)/sec
Paper feed density	10 dots/mm
MEMORY (High-speed recording)	
Time axis	5 μs to 5 min/div (100 samples/div) 26 ranges, external sampling (100 samples/div, or free setting), time axis zoom: × 2 to × 10 in 3 stages, compression: 1/2 to 1/200,000 in 16 stages
Sampling period	1/100 of time axis range (minimum 50 ns period)
Recording length	MR8847-51: 32 ch mode: 25 div to 20,000 div, 2 ch mode: 25 div to 200,000 div (built-in presets) or arbitrary setting in 1-div steps (max. 320,000 div*) MR8847-52: 32 ch mode: 25 div to 50,000 div, 2 ch mode: 25 div to 1,000,000 div (built-in presets) or arbitrary setting in 1-div steps (max. 1,280,000 div*) MR8847-53: 32 ch mode: 25 div to 100,000 div, 2 ch mode: 25 div to 2,000,000 div (built-in presets) or arbitrary setting in 1-div steps (max. 2,560,000 div*) * Limited by the number of channels used <i>Note: When U8975, U8977 or U8978 is installed, the recording length is fixed to 32 ch mode. 2ch, 4ch, or 8ch mode can not selected.</i>
Pre-trigger	Record data from before the trigger point at 0 to +100% or -95% of the recording length in 15 stages, or in 1 div step settings
Numerical calculations	- Simultaneous calculation for up to 16 selected channels Average value, effective (rms) value, peak to peak value, maximum value, time to maximum value, minimum value, time to minimum value, period, frequency, rise time, fall time, standard deviation, area value, X-Y area value, specified level time, specified time level, pulse width, duty ratio, pulse count, arithmetic operations, time difference, phase difference, high-level and low-level - Calculation result evaluation output: GO/NG (with open-collector 5 V output) - Automatic saving of calculation results
Waveform processing	- For up to 16 freely selectable channels, the following functions can be performed (results are automatically stored): automatic saving of arithmetic calculations, absolute value, exponentiation, common logarithm, square root, moving average, differentiation (primary, secondary), integration (primary, secondary), parallel displacement along time axis, trigonometric functions, reverse trigonometric functions, calculation results
Memory segmentation	- Max. 1,024 blocks, sequential storage, multi-block storage
Other	- No logging - X-Y waveform synthesis (1-screen, 4-screens) - Overlay (always overlay when started, overlay only required waveforms) - Automatic/manual/A-B cursor range printing, report printing
RECORDER (real-time recording)	
Time axis	10 ms/div to 1 hour/div, 19 ranges, time axis resolution 100 points/div * Out of data acquired at selected sampling rate, only maximum and minimum value data determined using 100 points/div units are stored. Time axis compression selectable in 14 steps, from ×1/2 to ×1/50,000
Sampling period	1 μs, 10 μs, 100 μs, 1 ms, 10 ms, 100 ms (selectable from 1/100 or less of time axis)
Real-time printing	Supported * Real-time printing is possible at time axis settings slower than 500 ms/div * Delayed print is performed when recording length is not set to "Continuous" and time axis setting is 10 ms to 200 ms/div * When recording length is set to "Continuous" and time axis setting is 10 ms to 200 ms/div, manual printing can be performed after measurement stop
Recording length	MR8847-51: built-in presets of 25 to 20,000 div, or "Continuous" or arbitrary setting in 1-div steps (max. 20,000 div) MR8847-52: built-in presets of 25 to 50,000 div, or "Continuous" or arbitrary setting in 1-div steps (max. 80,000 div) MR8847-53: built-in presets of 25 to 100,000 div, or "Continuous" or arbitrary setting in 1-div steps (max. 160,000 div) * When using U8975, U8977 or U8978, the maximum recording length is half of the above
Additional recording	Supported (recording is resumed without overwriting previous data)
Waveform memory	MR8847-51: stores data for most recent 20,000 div in memory MR8847-52: stores data for most recent 80,000 div in memory MR8847-53: stores data for most recent 160,000 div in memory * Backward scrolling and re-printing available * When using U8978, U8977 or U8978, the length of the stored data is half of the above
Auto saving	Data are automatically saved on CF card, USB memory stick or internal drive after measurement stops.
Other	- No logging - Manual/A-B cursor range printing, report printing
X-Y RECORDER (X-Y real-time recording)	
Sampling period	1 ms, 10 ms, 100 ms (dot), 10 ms, 100 ms (line)
Recording length	Continuous
Screen, printing	Split screen (1 or 4), manual printing only
Number of X-Y	1 to 8 phenomena
X-Y channel setting	Any 8 channels out of 16 can be selected for X axis and Y axis respectively
X-Y axis resolution	25 dots/div (screen), horizontal 80 dots/div × vertical 80 dots/div (printer)
Waveform memory	Sampling data for last the 4,000,000 points are stored in memory * When using U8975, U8977, or U8978, the last 2,000,000 points are stored in memory
Pen up/down	Simultaneous for all phenomena
External pen control	Possible via external input connector (simultaneous up/down for all phenomena)

Trigger functions	
Trigger mode	MEMORY (high-speed recording), FFT: single, repeat, auto RECORDER (real-time recording): single, repeat
Trigger source	Ch 1 to ch 16 (analog), atandard logic 16 ch + logic unit (max. 3 units 48 channels), external (a rise of 2.5 V or terminal short circuit), timer, manual (either on or off for each source), logic and/or of sources
Trigger types	- Level: triggering occurs when preset voltage level is crossed (upwards or downwards) - Voltage drop: triggering occurs when voltage drops below peak voltage setting (for 50/60 Hz commercial power supply only) - Window: triggering occurs when window defined by upper and lower limit is entered or exited - Period: rising edge or falling edge cycle of preset voltage value is measured and triggering occurs when defined cycle range is exceeded - Glitch: triggering occurs when pulse width from rising or falling edge of preset voltage value is under run - Event setting: event count is performed for each source, and triggering occurs when a preset count is exceeded - Logic: 1, 0, or x, pattern setting
Level setting resolution	0.1% of full scale (full scale = 20 divisions)
Trigger filter	Selectable 0.1 div to 10.0 div, or off (high-speed recording) On (10 ms fixed) or off (on RECORDER function)
Trigger output	Open collector (5 voltage output, active-low) At level setting: pulse width (sampling period x data number after trigger) At pulse setting: pulse width (2 ms)
Other functions	Trigger priority (off/on), pre-trigger function for capturing data from before/after trigger event (on MEMORY function), level display during trigger standby, start and stop trigger (at RECORDER function), trigger search function

FFT function	
Analysis modes	Storage waveform, linear spectrum, RMS spectrum, power spectrum, density of power spectrum, cross power spectrum, auto-correlation function, histogram, transfer function, cross-correlation function, impulse response, coherence function, 1/1 octave analysis, 1/3 octave analysis, LPC analysis, phase spectrum
Analysis channels	Selectable from all analog input channels
Frequency range	133 mHz to 8 MHz, external (resolution 1/400, 1/800, 1/2,000, 1/4,000)
Number of sampling points	1,000, 2,000, 5,000, 10,000 points
Window functions	Rectangular, hanning, hamming, blackman, blackman-harris, flat-top, exponential
Display format	Single, dual, nyquist, running spectrum
Averaging function	Time/frequency axis simple averaging, exponential averaging, peak hold (frequency axis), averaging times: 2 times to 10,000 times
Print functions	Same as the MEMORY function (partial print not available)
Other	
Waveform judgment function (in MEMORY or FFT function)	- Area comparison with reference waveform area for time domain waveform, X-Y waveform, or FFT analysis waveform - Parameter calculated value comparison with reference value - Output: GO/NG decision, open-collector: 5 V *100 msec/div (1 msec sampling) and thereafter allows for evaluation in almost real-time.

- Maximum internal memory recording time (MEMORY function)

		MR8847-51 (64 M-words)			MR8847-52 (256 M-words)			MR8847-53 (512 M-words)		
		Analog 32 ch + internal logic 16 ch	Analog 16 ch + internal logic 16 ch	Analog 2 ch + internal logic 16 ch	Analog 32 ch + internal logic 16 ch	Analog 16 ch + internal logic 16 ch	Analog 2 ch + internal logic 16 ch	Analog 32 ch + internal logic 16 ch	Analog 16 ch + internal logic 16 ch	Analog 2 ch + internal logic 16 ch
Time axis	Sampling period	20,000 div	40,000 div	320,000 div	80,000 div	160,000 div	1,280,000 div	160,000 div	320,000 div	2,560,000 div
5 µs/div	50 ns	N/A	0.2 s	1.6 s	N/A	0.8 s	6.4 s	N/A	1.6 s	12.8 s
10 µs/div	100 ns	0.2 s	0.4 s	3.2 s	0.8 s	1.6 s	12.8 s	1.6 s	3.2 s	25.6 s
20 µs/div	200 ns	0.4 s	0.8 s	6.4 s	1.6 s	3.2 s	25.6 s	3.2 s	6.4 s	51.2 s
50 µs/div	500 ns	1 s	2 s	16 s	4 s	8 s	1 min 04 s	8 s	16 s	2 min 08 s
100 µs/div	1 µs	2 s	4 s	32 s	8 s	16 s	2 min 08 s	16 s	32 s	4 min 16 s
200 µs/div	2 µs	4 s	8 s	1 min 04 s	16 s	32 s	4 min 16 s	32 s	1 min 04 s	8 min 32 s
500 µs/div	5 µs	10 s	20 s	2 min 40 s	40 s	1 min 20 s	10 min 40 s	1 min 20 s	2 min 40 s	21 min 20 s
1 ms/div	10 µs	20 s	40 s	5 min 20 s	1 min 20 s	2 min 40 s	21 min 20 s	2 min 40 s	5 min 20 s	42 min 40 s
2 ms/div	20 µs	40 s	1 min 20 s	10 min 40 s	2 min 40 s	5 min 20 s	42 min 40 s	5 min 20 s	10 min 40 s	1 h 25 min 20 s
5 ms/div	50 µs	1 min 40 s	3 min 20 s	26 min 40 s	6 min 40 s	13 min 20 s	1 h 46 min 40 s	13 min 20 s	26 min 40 s	3 h 33 min 20 s
10 ms/div	100 µs	3 min 20 s	6 min 40 s	53 min 20 s	13 min 20 s	26 min 40 s	3 h 33 min 20 s	26 min 40 s	53 min 20 s	7 h 06 min 40 s
20 ms/div	200 µs	6 min 40 s	13 min 20 s	1 h 46 min 40 s	26 min 40 s	53 min 20 s	7 h 06 min 40 s	53 min 20 s	1 h 46 min 40 s	14 h 13 min 20 s
50 ms/div	500 µs	16 min 40 s	33 min 20 s	4 h 26 min 40 s	1 h 6 min 40 s	2 h 13 min 20 s	17 h 46 min 40 s	2 h 13 min 20 s	4 h 26 min 40 s	35 h 33 min 20 s
100 ms/div	1 ms	33 min 20 s	1 h 06 min 40 s	8 h 53 min 20 s	2 h 13 min 20 s	4 h 26 min 40 s	1 d 11 h 33 min 20 s	4 h 26 min 40 s	8 h 53 min 20 s	2 d 23 h 06 min 40 s
200 ms/div	2 ms	1 h 6 min 40 s	2 h 13 min 20 s	17 h 46 min 40 s	4 h 26 min 40 s	8 h 53 min 20 s	2 d 23 h 06 min 40 s	8 h 53 min 20 s	17 h 46 min 40 s	5 d 22 h 13 min 20 s
500 ms/div	5 ms	2 h 46 min 40 s	5 h 33 min 20 s	1 d 20 h 26 min 40 s	11 h 6 min 40 s	22 h 13 min 20 s	7 d 09 h 46 min 40 s	22 h 13 min 20 s	44 h 26 min 40 s	14 d 19 h 33 min 20 s
1 s/div	10 ms	5 h 33 min 20 s	11 h 06 min 40 s	3 d 16 h 53 min 20 s	22 h 13 min 20 s	1 d 20 h 26 min 40 s	14 d 19 h 33 min 20 s	1 d 20 h 26 min 40 s	3 d 16 h 53 min 20 s	29 d 15 h 06 min 40 s
2 s/div	20 ms	11 h 6 min 40 s	22 h 13 min 20 s	7 d 09 h 46 min 40 s	1 d 20 h 26 min 40 s	3 d 16 h 53 min 20 s	29 d 15 h 06 min 40 s	3 d 16 h 53 min 20 s	7 d 09 h 46 min 40 s	59 d 06 h 13 min 20 s
5 s/div	50 ms	1 d 3 h 46 min 40 s	2 d 07 h 33 min 20 s	18 d 12 h 26 min 40 s	4 d 15 h 6 min 40 s	9 d 06 h 13 min 20 s	74 d 01 h 46 min 40 s	9 d 6 h 13 min 20 s	18 d 12 h 26 min 40 s	148 d 03 h 33 min 20 s
10 s/div	100 ms	2 d 7 h 33 min 20 s	4 d 15 h 06 min 40 s	37 d 00 h 53 min 20 s	9 d 6 h 13 min 20 s	18 d 12 h 06 min 40 s	148 d 03 h 33 min 20 s	18 d 12 h 26 min 40 s	37 d 00 h 53 min 20 s	296 d 07 h 06 min 40 s
30 s/div	300 ms	6 d 22 h 40 min 0 s	13 d 21 h 20 min 00 s	111 d 02 h 40 min 00 s	27 d 18 h 40 min 0 s	55 d 13 h 20 min 00 s	444 d 10 h 40 min 00 s	55 d 13 h 20 min 0 s	111 d 02 h 40 min 00 s	888 d 21 h 20 min 00 s
50 s/div	500 ms	11 d 13 h 46 min 40 s	23 d 03 h 33 min 20 s	185 d 04 h 26 min 40 s	46 d 7 h 6 min 40 s	92 d 14 h 13 min 20 s	740 d 17 h 46 min 40 s	92 d 14 h 13 min 20 s	185 d 04 h 26 min 40 s	Omitted*
1 min/div	600 ms	13 d 21 h 20 min 0 s	27 d 18 h 40 min 00 s	222 d 05 h 20 min 00 s	55 d 13 h 20 min 0 s	111 d 02 h 40 min 00 s	888 d 21 h 20 min 00 s	111 d 2 h 40 min 0 s	222 d 05 h 20 min 00 s	Omitted*
100 s/div	1.0 s	23 d 3 h 33 min 20 s	46 d 07 h 06 min 40 s	370 d 08 h 53 min 20 s	92 d 14 h 13 min 20 s	185 d 04 h 26 min 40 s	Omitted*	185 d 4 h 26 min 40 s	370 d 08 h 53 min 20 s	Omitted*
2 min/div	1.2 s	27 d 1 h 8 h 40 min 0 s	55 d 13 h 20 min 00 s	444 d 10 h 40 min 00 s	111 d 2 h 40 min 0 s	222 d 05 h 20 min 00 s	Omitted*	222 d 5 h 20 min 0 s	444 d 10 h 40 min 00 s	Omitted*
5 min/div	3.0 s	69 d 10 h 40 min 0 s	138 d 21 h 20 min 00 s	Omitted*	277 d 18 h 40 min 0 s	555 d 13 h 20 min 00 s	Omitted*	555 d 13 h 20 min 0 s	Omitted*	Omitted*

Notes

- The above table shows maximum values at arbitrary recording length settings
 - When measuring at sampling speed of 100 msec/div (1 msec sampling) or slower, data can be saved to media while measuring
 - Operation cannot be guaranteed for extended recording periods of one year or longer. The above table represents theoretical values
- * Time periods of 1000 or more days have been omitted due to print spacing and presumed usefulness to the reader.

Optional specifications (sold separately)

Dimensions and weight: approx. 106 mm (4.17 in.) W x 19.8 mm (0.78 in.) H x 196.5 mm (7.74 in.) D, approx. 250 g (8.8 oz.)
Accessories: none



ANALOG UNIT 8966 (Accuracy at 23 ±5°C [73 ±9°F], 20% to 80% rh after 30 minutes of warm-up time and zero adjustment; accuracy guaranteed for 1 year)	
Measurement functions	Number of channels: 2, for voltage measurement
Input terminals	Isolated BNC connector (input impedance 1 MΩ, input capacitance 30 pF) Max. rated voltage to ground: 300 V AC or DC (with input isolated from the main unit, the maximum voltage that can be applied between input channel and chassis, and between input channels without damage)
Measurement ranges (/div)	5 mV/div to 20 V/div, 12 ranges, full scale: 20 div AC voltage for possible measurement/display using the memory function: 280 V rms Low-pass filter: 5 Hz, 50 Hz, 500 Hz, 5 kHz, 50 kHz, 500 kHz
Measurement resolution	1/100 of range (using 12-bit A/D conversion)
Maximum sampling rate	20 MS/s (simultaneous sampling in 2 channels)
Measurement accuracy	±0.5% of full scale (with filter 5 Hz, zero position accuracy included)
Frequency characteristics	DC to 5 MHz, -3 dB (with AC coupling: 7 Hz to 5 MHz, -3 dB)
Input coupling	AC/DC/GND
Maximum input voltage	400 V DC (maximum voltage that can be applied between input connectors without damage)

Dimensions and weight: approx. 106 mm (4.17 in.) W x 19.8 mm (0.78 in.) H x 196.5 mm (7.74 in.) D, approx. 250 g (8.8 oz.)
Accessories: none

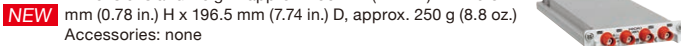

4ch ANALOG UNIT U8975 (Accuracy at 23 ±5°C [73 ±9°F], 20% to 80% RH after 30 minutes of warm-up time and zero adjustment; accuracy guaranteed for 1 year)	
Measurement functions	Number of channels: 4, for voltage measurement
Input terminals	Isolated BNC connector (input impedance 1 MΩ, input capacitance 30 pF) Max. rated voltage to ground: 300 V AC, DC (with input isolated from the unit, the maximum voltage that can be applied between input channel and chassis and between input channels without damage)
Measurement range	4 V, 10 V, 20 V, 40 V, 100 V, 200 V f.s., 6 ranges AC voltage for possible measurement/display: 140 V rms Low-pass filter: 5 Hz, 500 Hz, 5 kHz, 200 kHz
Measurement resolution	1/32,000 of measurement range (using 16-bit A/D conversion)
Maximum sampling rate	5 MS/s (simultaneous sampling in 4 channels)
Measurement accuracy	±0.1% f.s. (with filter 5 Hz, zero position accuracy included)
Frequency characteristics	DC to 2 MHz, -3 dB
Input coupling	DC/GND
Maximum input voltage	200 V DC (the maximum voltage that can be applied across input pins without damage)

Dimensions and weight: approx. 106 mm (4.17 in.) W x 19.8 mm (0.78 in.) H x 196.5 mm (7.74 in.) D, approx. 250 g (8.8 oz.)
Accessories: none

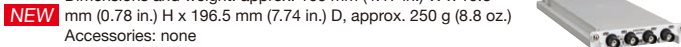

4CH ANALOG UNIT U8978 (Accuracy at 23 ±5°C [73 ±9°F], 20% to 80% RH after 30 minutes of warm-up time and zero adjustment; accuracy guaranteed for 1 year)	
Measurement functions	Number of channels: 4, for voltage measurement
Input terminals	Isolated BNC connector (input impedance 1 MΩ, input capacitance 30 pF) Max. rated voltage to ground: 30 V AC or 60 V DC for direct input, 300 V AC, DC (CAT II) when combined with the 9665 (between each input channel and the main unit, and between the input channels)
Measurement range	100 mV, 200 mV, 400 mV, 1 V, 2 V, 4 V, 10 V, 20 V, 40 V f.s., 9 ranges Low-pass filter: 5 Hz, 500 Hz, 5 kHz, 200 kHz
Measurement resolution	1/32,000 of measurement range (using 16-bit A/D conversion)
Maximum sampling rate	5 MS/s (simultaneous sampling in 4 channels)
Measurement accuracy	±0.3% f.s. (with filter 5 Hz, zero position accuracy included)
Frequency characteristics	DC to 2 MHz, -3 dB
Input coupling	DC/GND
Maximum input voltage	40 V DC (with direct input), 400 V DC (with 9665)

Dimensions and weight: approx. 106 mm (4.17 in.) W x 19.8 mm (0.78 in.) H x 204.5 mm (8.05 in.) D, approx. 240 g (8.5 oz.)
Accessories: ferrite clamp x 2



TEMP UNIT 8967 (Accuracy at 23 ±5°C [73 ±9°F], 20% to 80% rh after 30 minutes of warm-up time and zero adjustment; accuracy guaranteed for 1 year)	
Measurement functions	Number of channels: 2, for temperature measurement with thermocouple (voltage measurement not available)
Input terminals	Thermocouple input: plug-in connector, recommended wire diameter: single-wire, 0.14 mm ² to 1.5 mm ² , braided wire 0.14 mm ² to 1.0 mm ² (conductor wire diameter min. 0.18 mm), AWG 26 to 16 Input impedance: min. 5 MΩ (with line fault detection on/off) Max. rated voltage to ground: 300 V AC or DC (with input isolated from the main unit, the maximum voltage that can be applied between input channel and chassis, and between input channels without damage)
Temperature measurement range	10°C (50°F)/div (-100°C to 200°C [-148°F to 392°F]), 50°C (122°F)/div (-200°C to 1,000°C [-328°F to 1,832°F]), 100°C (212°F)/div (-200°C to 2,000°C [-328°F to 3,632°F]), 3 ranges, full scale: 20 div, Measurement resolution: 1/1,000 of measurement range (using 16-bit A/D conversion)
Thermocouple range (JIS C 1602-1995) (ASTM E-988-96)	K: -200°C to 1,350°C (-328°F to 2,462°F), J: -200°C to 1,100°C (-328°F to 2,012°F), E: -200°C to 800°C (-328°F to 1,472°F), T: -200°C to 400°C (-328°F to 752°F), N: -200°C to 1,300°C (-328°F to 2,372°F), R: 0°C to 1,700°C (32°F to 3,092°F), S: 0°C to 1,700°C (32°F to 3,092°F), B: 400°C to 1,800°C (752°F to 3,272°F), W (WRε5-26): 0°C to 2,000°C (32°F to 3,632°F), Reference junction compensation: internal/external (switchable), line fault detection on/off possible
Data refresh rate	3 methods, fast: 1.2 ms (digital filter off), normal: 100 ms (digital filter 50/60 Hz), slow: 500 ms (digital filter 10 Hz)
Measurement accuracy	Thermocouple K, J, E, T, N: ±0.1% of full scale ±1°C (±1.8°F) (±0.1% of full scale ±2°C (±3.6°F) at -200°C to 0°C [-328°F to 32°F]), Thermocouple R, S, B, W: ±0.1% of full scale ±3.5°C (±6.3°F) (at 0°C [32°F] to less than 400°C [752°F]); however, no accuracy guarantee of less than 400°C [752°F] for B), ±0.1% f.s. ±3°C (±5.4°F) (at 400°C [752°F] or more) Reference junction compensation accuracy: ±1.5°C (±2.7°F) (added to measurement accuracy with internal reference junction compensation)

Dimensions and weight: approx. 106 mm (4.17 in.) W x 19.8 mm (0.78 in.) H x 196.5 mm (7.74 in.) D, approx. 250 g (8.8 oz.)

Accessories: CONVERSION CABLE 9318 x 2 (to connect the current sensors to the 8971)



CURRENT UNIT 8971 (Accuracy at 23 ±5°C [73 ±9°F], 20% to 80% rh after 30 minutes of warm-up time and zero adjustment; accuracy guaranteed for 1 year)	
Measurement functions	Number of channels: 2, for current measurement with optional current sensor
Input terminals	Sensor connector (input impedance 1 MΩ, exclusive connector for current sensor via conversion cable the 9318, common GND with recorder)
Compatible current sensors and measurement range (f.s. = 20 div)	Using 9272-05 (at 20 A range) or CT6841-05: 100 mA, 200 mA, 500 mA, 1 A, 2 A, 5 A Using CT6862-05: 200 mA, 500 mA, 1 A, 2 A, 5 A, 10 A Using 9272-05 (at 200 A range), CT6843-05 or CT6863-05: 1 A, 2 A, 5 A, 10 A, 20 A, 50 A Using CT6844-05, CT6845-05, CT6846-05, CT6875, or CT6876: 2 A, 5 A, 10 A, 20 A, 50 A, 100 A How to connect to 8971: use Conversion Cable 9318 + Conversion Cable CT9901
Measurement accuracy (with 5 Hz filter on) Note: add the accuracy and attributes of the current sensor being used	±0.65% f.s. RMS amplitude accuracy: ±1% f.s. (DC, 30 Hz to 1 kHz), ±3% f.s. (1 kHz to 10 kHz) RMS response time: 100 ms (rise time from 0% to 90% of full scale) Crest factor: 2 Frequency characteristics: DC to 100 kHz, ±3 dB (with AC coupling: 7 Hz to 100 kHz)
Measurement resolution	1/100 of range (using 12-bit A/D conversion)
Maximum sampling rate	1 MS/s (simultaneous sampling in 2 channels)
Other functions	Input coupling: AC/DC/GND, low-pass filter: 5 Hz, 50 Hz, 500 Hz, 5 kHz, 50 kHz

Dimensions and weight: approx. 106 mm (4.17 in.) W x 19.8 mm (0.78 in.) H x 196.5 mm (7.74 in.) D, approx. 250 g (8.8 oz.)

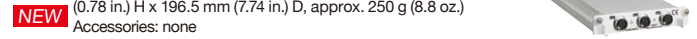

3CH CURRENT UNIT U8977 (Accuracy at 23 ±5°C [73 ±9°F], 20% to 80% RH after 30 minutes of warm-up time and zero adjustment; accuracy guaranteed for 1 year)	
Measurement functions	No. of channels: 3, current measurement with optional current sensor
Input terminals	Dedicated connector terminal (ME15W) (input impedance 1 MΩ, common GND with recorder)
Compatible current sensors and measurement range	- Directly connected current sensor: automatically identify rating of compatible current sensors Using 9272-05 (at 20 A range) or CT6841-05: 2 A, 4 A, 10 A, 20 A, 40 A, 100 A f.s. Using CT6862-05: 4 A, 10 A, 20 A, 40 A, 100 A, 200 A f.s. Using 9272-05 (at 200 A range), CT6843-05 or CT6863-05: 20 A, 40 A, 100 A, 200 A, 400 A, 1,000 A f.s. Using CT6844-05, CT6845-05, CT6904, or CT6875: 40 A, 100 A, 200 A, 400 A, 1,000 A, 2,000 A f.s. Using CT6846-05 or CT6876: 100 A, 200 A, 400 A, 1,000 A, 2,000 A, 4,000 A f.s. Using CT6877: 200 A, 400 A, 1,000 A, 2,000 A, 4,000 A, 10,000 A f.s. - Current sensors connected using CT9920: select conversion rate or model Using CT7631 or CT7731: 200 A Using CT7636 or CT7736: 200 A, 400 A, 1,000 A Using CT7642 or CT7742: 2,000 A, 4,000 A Using CT7044, CT7045 or CT7046: 2,000 A, 4,000 A, 10,000 A
Measurement accuracy (with 5 Hz filter on) Note: add the accuracy and attributes of the current sensor being used.	±0.3% f.s. Frequency characteristics: DC to 2 MHz, ±3 dB
Measurement resolution	1/32,000 of measurement range (using 16-bit A/D conversion)
Maximum sampling rate	5 MS/s (simultaneous sampling in 3 channels)
Other functions	Input coupling: DC/GND, low-pass filter: 5 Hz, 500 Hz, 5 kHz, 200 kHz

Dimensions and weight: approx. 106 mm (4.17 in.) W x 19.8 mm (0.78 in.) H x 196.5 mm (7.74 in.) D, approx. 250 g (8.8 oz.)

Accessories: none



FREQ UNIT 8970 (Accuracy at 23 ±5°C [73 ±9°F], 20% to 80% rh after 30 minutes of warm-up time; accuracy guaranteed for 1 year)	
Measurement functions	Number of channels: 2, for voltage input based frequency measurement, rotation, power frequency, integration, pulse duty ratio, pulse width
Input terminals	Isolated BNC connector (input impedance 1 MΩ, input capacitance 30 pF) Max. rated voltage to ground: 300 V AC or DC (with input isolated from the main unit, the maximum voltage that can be applied between input channel and chassis, and between input channels without damage)
Frequency mode	Range: between DC to 100 kHz (minimum pulse width 2 μs), 1 Hz/div to 5 kHz/div (full scale = 20 div), 8 settings Accuracy: ±0.1% f.s. (exclude 5 kHz/div), ±0.7% f.s. (at 5 kHz/div)
Rotation mode	Range: between 0 to 2 million rotations/minute (minimum pulse width 2 μs), 100 (r/min)/div to 100 k(r/min)/div (full scale = 20 div), 7 settings Accuracy: ±0.1% f.s. (excluding 100 k(r/min)/div), ±0.7% f.s. (at 100 k(r/min)/div)
Power frequency mode	Range: 50 Hz (40 Hz to 60 Hz), 60 Hz (50 Hz to 70 Hz), 400 Hz (390 Hz to 410 Hz) (full scale = 20 div), 3 settings Accuracy: ±0.03 Hz (50Hz, 60 Hz), ±0.1 Hz (400 Hz range)
Integration mode	Range: 2 k-counts/div to 1 M-counts/div, 6 settings Accuracy: ±range/2,000
Duty ratio mode	Range: between 10 Hz to 100 kHz (min. pulse width 2 μs), 5%/div (full scale = 20 div) Accuracy: ±1% (10 Hz to 10 kHz), ±4% (10 kHz to 100 kHz)
Pulse width mode	Range: between 2 μs to 2 sec, 500 μs/div to 100 ms/div (full scale = 20 div) Accuracy: ±0.1% f.s.
Measurement resolution	1/2,000 of range (integration mode), 1/500 of range (exclude integration, power frequency mode), 1/100 of range (power frequency mode)
Input voltage range and threshold level	±10 V to ±400 V, 6 settings, selectable threshold level at each range
Other functions	Slope, level, hold, smoothing, low-pass filter, switchable DC/AC input coupling, frequency dividing, integration over-range keep/return

Dimensions and weight: approx. 106 mm (4.17 in.) W x 19.8 mm (0.78 in.) H x 196.5 mm (7.74 in.) D, approx. 190 g (6.7 oz.)

Accessories: none



LOGIC UNIT 8973	
Measurement functions	Number of channels: 16 channels (4 ch/probe connector, x 4 connectors)
Input terminals	Mini DIN connector (for Hioki logic probes only) Compatible logic probes: 9320-01, 9327, MR9321-01

Dimensions and weight: approx. 106 mm (4.17 in.) W × 19.8 mm (0.78 in.) H × 196.5 mm (7.74 in.) D, approx. 260 g (9.2 oz.)
Accessories: none



DIGITAL VOLTMETER UNIT MR8990 (Accuracy at 23 ±5°C [73 ±9°F], 20% to 80% rh after 30 minutes of warm-up time and calibration, accuracy guaranteed for 1 year)	
Measurement functions	Number of channels: 2, for DC voltage measurement
Input terminals	Banana input connectors (input resistance: 100 MΩ or higher with 100 mV f.s. to 10 V f.s. range, otherwise 10 MΩ) Max. rated voltage to ground: 300 V AC or DC (with input isolated from the main unit, the maximum voltage that can be applied between input channel and chassis, and between input channels without damage)
Measurement range	100 mV f.s. (5 mV/div) to 1,000 V f.s. (50 V/div), 5 ranges, full scale: 20 div
Measurement resolution	1/50,000 of measurement range (using 24 bit ΔΣ modulation A/D)
Integration time	20 ms × NPLC (during 50 Hz), 16.67 ms × NPLC (during 60 Hz)
Response time	2 ms + 2 × integration time or less (rise - f.s. → + f.s., fall + f.s. → - f.s.)
Basic measurement accuracy	±0.01% rdg. ±0.0025% f.s. (at range of 1,000 mV f.s.)
Maximum input voltage	500 V DC (maximum voltage that can be applied between input connectors without damage)

Dimensions and weight: approx. 106 mm (4.17 in.) W × 19.8 mm (0.78 in.) H × 196.5 mm (7.74 in.) D, approx. 230 g (8.1 oz.)
Accessories: none



HIGH-VOLTAGE UNIT U8974 (Accuracy at 23 ±5°C [73 ±9°F], 20% to 80% rh after 30 minutes of warm-up time and zero adjustment, accuracy guaranteed for 1 year)	
Measurement functions	Number of channels: 2, for voltage measurement, DC/RMS selectable Maximum rated voltage to ground: 1,000 V AC or DC (CAT III), 600 V AC or DC (CAT IV)
Input terminals	Banana input terminal (input impedance: 4 MΩ, Input capacitance: 5 pF)
Measurement ranges/div	200 mV, 500 mV, 1 V, 2 V, 5 V, 10 V, 20 V, 50 V (DC mode) 500 mV, 1 V, 2 V, 5 V, 10 V, 20 V, 50 V (RMS mode)
Measurement resolution	1/1,600 of measurement range (using 16-bit A/D conversion)
Maximum sampling rate	1 MS/s
Measurement accuracy	±0.25% f.s. (with filter 5 Hz, zero position accuracy included)
RMS measurement	RMS accuracy: ±1.5% f.s. (DC, 30 Hz to 1 kHz), ±3% f.s. (1 kHz to 100 kHz) Response time: high speed 150 ms, medium speed 500 ms, low speed 2.5 s
Frequency characteristics	DC to 100 kHz, -3 dB
Input coupling	DC/GND
Maximum input voltage	1,000 V DC, 700 V AC

Dimensions and weight: approx. 106 mm (4.17 in.) W × 19.8 mm (0.78 in.) H × 196.5 mm (7.74 in.) D, approx. 250 g (8.8 oz.)
Accessories: none



DC/RMS UNIT 8972 (Accuracy at 23 ±5°C [73 ±9°F], 20% to 80% rh after 30 minutes of warm-up time and zero adjustment, accuracy guaranteed for 1 year)	
Measurement functions	Number of channels: 2, for voltage measurement, DC/RMS selectable
Input terminals	Isolated BNC connector (input impedance 1 MΩ, input capacitance 30 pF) Max. rated voltage to ground: 300 V AC or DC (with input isolated from the main unit, the maximum voltage that can be applied between input channel and chassis, and between input channels without damage)
Measurement range	5 mV/div to 20 V/div, 12 ranges, full scale: 20 div AC voltage for possible measurement/display using the memory function: 280 V rms Low-pass filter: 5 Hz, 50 Hz, 500 Hz, 5 kHz, 100 kHz
Measurement resolution	1/100 of range (using 12-bit A/D conversion)
Maximum sampling rate	1 MS/s (simultaneous sampling in 2 channels)
Measurement accuracy	±0.5% of full scale (with filter 5 Hz, zero position accuracy included)
RMS measurement	RMS amplitude accuracy: ±1% f.s. (DC, 30 Hz to 1 kHz), ±3% of full scale (1 kHz to 100 kHz) Response time: SLOW 5 s (rise time from 0% to 90% of full scale), MID 800 ms (rise time from 0% to 90% of full scale), FAST 100 ms (rise time from 0% to 90% of full scale), crest factor: 2
Frequency characteristics	DC to 400 kHz, -3 dB (with AC coupling: 7 Hz to 400 kHz, -3 dB)
Input coupling	AC/DC/GND
Maximum input voltage	400 V DC (maximum voltage that can be applied between input connectors without damage)

Dimensions and weight: approx. 106 mm (4.17 in.) W × 19.8 mm (0.78 in.) H × 196.5 mm (7.74 in.) D, approx. 230 g (8.1 oz.)
Accessories: none



CHARGE UNIT U8979 (Accuracy at 23 ±5°C [73 ±9°F], 80% rh or less, after 30 minutes of warm-up time and zero adjustment, Accuracy guaranteed for 1 year)	
Measurement functions	Number of channels: 2, for acceleration measurement
Input terminals	Voltage input, pre-amp embedded input: metal BNC connector (under voltage input: input impedance 1 MΩ, input capacitance 200 pF or less) Charge input: miniature connector (#10-32UNF) Max. rated voltage to ground: 30 V AC or 60 V DC (with input isolated from the main unit, the maximum voltage that can be applied between input channel and chassis, and between input channels without damage) *Voltage input terminal GND and charge input terminal GND for the same channel are shared
Suitable transducer	Charge output type acceleration detector Pre-amp embedded acceleration detector (IEPE type)
Measurement range	1 (m/s ²) to 200k (m/s ²) f.s., 12 ranges × 6 types Charge input sensitivity: 0.1 pC/(m/s ²) to 10 pC/(m/s ²) Pre-amp embedded sensor input sensitivity: 0.1 mV/(m/s ²) to 10 mV/(m/s ²) Amplitude accuracy: ±2% f.s., frequency characteristics: 1 (1.5 Hz) to 50 kHz, -3 dB (charge input) Low-pass filter: 500 Hz, 5 kHz Pre-amp supply power: 3.5 mA ±20%, 22 V ±5% Maximum input charge: ±500 pC (6 ranges on high sensitivity side), 50,000 pC (6 ranges on low sensitivity side)
Measurement range	10 mV to 40 V f.s., 12 ranges, DC amplitude accuracy: ±0.5% f.s. Frequency characteristics: DC to 50 kHz, -3 dB (with DC coupling), 1 Hz to 50 kHz, -3 dB (with AC coupling)
Measurement resolution	1/25,000 of measurement range (using 16-bit A/D conversion)
Maximum sampling rate	200 kS/s
Anti-aliasing filter	Integrated filter for suppressing aliasing distortion caused by FFT processing (automatic cutoff frequency setting/off)
TEDS	IEEE 1451.4 class 1 support (support for sensor information reading and automatic sensitivity setting)

Dimensions and weight: approx. 106 mm (4.17 in.) W × 19.8 mm (0.78 in.) H × 196.5 mm (7.74 in.) D, approx. 250 g (8.8 oz.)
Accessories: none



HIGH RESOLUTION UNIT 8968 (Accuracy at 23 ±5°C [73 ±9°F], 20% to 80% rh after 30 minutes of warm-up time and zero adjustment, accuracy guaranteed for 1 year)	
Measurement functions	Number of channels: 2, for voltage measurement
Input terminals	Isolated BNC connector (input impedance 1 MΩ, input capacitance 30 pF) Max. rated voltage to ground: 300 V AC, DC (with input isolated from the unit, the maximum voltage that can be applied between input channel and chassis and between input channels without damage)
Measurement range	5 mV/div to 20 V/div, 12 ranges, full scale: 20 div AC voltage for possible measurement/display using the memory function: 280 V rms Low-pass filter: 5 Hz, 50 Hz, 500 Hz, 5 kHz, 50 kHz
Anti-aliasing filter	Integrated filter for suppressing aliasing distortion caused by FFT processing (automatic cutoff frequency setting on/off)
Measurement resolution	1/1,600 of measurement range (using 16-bit A/D conversion)
Maximum sampling rate	1 MS/s (simultaneous sampling in 2 channels)
Measurement accuracy	±0.3% of full scale (with filter 5 Hz, zero position accuracy included)
Frequency characteristics	DC to 100 kHz, -3 dB (with AC coupling: 7 Hz to 100 kHz, -3 dB)
Input coupling	AC/DC/GND
Maximum input voltage	400 V DC (maximum voltage that can be applied between input connectors without damage)

Dimensions and weight: approx. 106 mm (4.17 in.) W × 19.8 mm (0.78 in.) H × 196.5 mm (7.74 in.) D, approx. 245 g (8.6 oz.)
Accessories: conversion cable L9769 × 2 (cable length 60 cm [1.97 ft.])



STRAIN UNIT U8969 (Accuracy at 23 ±5°C [73 ±9°F], 80% rh or less, after 30 minutes of warm-up time and auto-balancing accuracy guaranteed for 1 year)	
Measurement functions	Number of channels: 2, for distortion measurement (electronic auto-balancing, balance adjustment range within ±10,000 μe or less)
Input terminals	NDIS connector EPRC07-R9FNDIS (via Conversion Cable L9769 and NDIS connector PRC03-12A10-7M10.5) Max. rated voltage to ground: 30 V rms or 60 V DC (with input isolated from the unit, the maximum voltage that can be applied between input channel and chassis and between input channels without damage)
Suitable transducer	Strain gauge converter, bridge impedance: 120 Ω to 1 kΩ, bridge voltage: 2 V ±0.05 V, gauge rate: 2.0
Measurement range	20 to 1,000 μe/div, 6 ranges, full scale: 20 div, low-pass filter: 5 Hz, 10 Hz, 100 Hz, 1 kHz
Measurement resolution	1/1,250 of measurement range (using 16-bit A/D conversion)
Maximum sampling rate	200 kS/s (simultaneous sampling across 2 channels)
Measurement accuracy	±0.5% f.s. ±4 μe (5 Hz filter on)
After auto-balancing	
Frequency characteristics	DC to 20 kHz, +1/-3 dB

Dimensions and weight: approx. 106 mm (4.17 in.) W × 19.8 mm (0.78 in.) H × 196.5 mm (7.74 in.) D, approx. 250 g (8.8 oz.)
Accessories: none



ARBITRARY WAVEFORM GENERATOR UNIT U8793 (Accuracy at 23 ±5°C [73 ±9°F], 80% rh or less after 30 minutes or more of warm-up time; power supply frequency range of installed MEMORY HiCORDER at 50/60 Hz ±2 Hz; accuracy guaranteed for 1 year)	
Output terminal	Number of channels: 2, SMB terminal (output impedance: 1 Ω or less) Max. rated voltage to ground: 30 V rms AC or 60 V DC
Output voltage range	-10 V to 15 V (amplitude setting range: 0 V to 20 V p-p, setting resolution: 1 mV)
Max. output current	10 mA (allowable load resistance: 1.5 kΩ or more)
FG function	DC, sine wave, square wave, pulse wave, triangular wave, ramp wave Output frequency: 0 Hz to 100 kHz
Arbitrary waveform generator mode	Waveforms measured by MR8847A, etc., generated by Hiki model 7075 or SF8000, CSV waveforms D/A refresh rate: 2 MHz (using 16-bit D/A)
Sweep function	Frequency, amplitude, offset, duty (pulse only)
Program function	Max. 128 steps (number of loops for each step, number of total loops)
Other	Self-test function (voltage), external input/output control

Dimensions and weight: approx. 106 mm (4.17 in.) W × 19.8 mm (0.78 in.) H × 196.5 mm (7.74 in.) D, approx. 230 g (8.1 oz.)
Accessories: none



WAVEFORM GENERATOR UNIT MR8790 (Accuracy at 23 ±5°C [73 ±9°F], 80% rh after 30 minutes of warm-up time; accuracy guaranteed for 1 year)	
Output terminal	Number of channels: 4, SMB terminal (output impedance: 1 Ω or less) Max. rated voltage to ground: 30 V rms AC or 60 V DC
Output voltage range	-10 V to 10 V (amplitude setting range: 0 V to 20 V p-p, setting resolution: 1 mV)
Max. output current	5 mA
Output function	DC, sine wave (output frequency range: 0 Hz to 20 kHz)
Accuracy	Amplitude accuracy: ±0.25% of setting ±2 mV p-p (1 Hz to 10 kHz) Offset accuracy: ±3 mV DC output accuracy: ±0.6 mV
Other	Self-test function (voltage, current)

Dimensions and weight: approx. 106 mm (4.17 in.) W × 19.8 mm (0.78 in.) H × 196.5 mm (7.74 in.) D, approx. 230 g (8.1 oz.)
Accessories: none



PULSE GENERATOR UNIT MR8791 (Accuracy at 23 ±5°C [73 ±9°F], 80% rh or less with no condensation; accuracy guaranteed for 1 year)	
Output terminal	Number of channels: 8, Connector: D-sub, half-pitch, 50-pin Max. rated voltage to ground: 30 V rms AC or 60 V DC (between unit and output channels) Logic output, open collector output
Output mode 1	Pattern output: read frequency: 0 Hz to 120 kHz, 2,048 logic patterns Pulse output: frequency 0 Hz to 20 kHz, duty 0.1% to 99.9%
Output mode 2	Logic output voltage level: 0 V to 5 V (high level: 3.8 V or more, low level: 0.8 V or less) Open collector output: 50 V absolute maximum rated voltage for collector/emitter Overcurrent protection: 100 mA
Other	Self-test function

System Chart of Options

For more information, please refer to the product information on the HIOKI website.

Model : MEMORY HiCORDER MR8847A

Model No. (order code) (note)

MR8847-51	(MR8847A, 64 M-word memory, main unit only)
MR8847-52	(MR8847A, 256 M-word memory, main unit only)
MR8847-53	(MR8847A, 512 M-word memory, main unit only)

**Cannot operate alone. You must install other options*



Note: main unit MR8847A cannot operate alone. You must install one or more optional input modules in the unit.

Printer options



RECORDING PAPER 9231
A4 width 216 mm (8.50 in.) x 30 mm (98.43 ft.), 6 rolls/set

Factory-installed option *Must specify when ordering



DC POWER UNIT 9784
Factory-installed option (not user installable), built in on the bottom case. 10 V to 28 V DC drive.

SSD UNIT U8331
Specified upon order; built-in type, 128 GB

Storage media

Use only the CF Cards or USB drive sold by Hioki. Compatibility and performance are not guaranteed for CF cards or USB memory sticks made by other manufacturers. You may be unable to read from or save data to such cards.



PC CARD 2G 9830
2 GB, PC card adapter included

PC CARD 1G 9729
1 GB, PC card adapter included

PC CARD 512M 9728
512 MB, PC card adapter included

USB DRIVE Z4006
16 GB, long-life, high-reliability SLC flash memory

PC Software

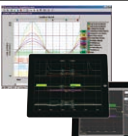

WAVE PROCESSOR 9335
Convert data, print and display waveforms

LAN COMMUNICATOR 9333

- Waveform data collect function
- Remote control with the PC

iPad App for MEMORY HiCORDER HMR Terminal
Download from the App Store (exclusively for Apple iPad)

Waveform Viewer Wv (standard accessory)
Software for checking waveforms with binary data on a PC, saving data in CSV format, and transferring to spreadsheet programs



LAN CABLE 9642
Straight Ethernet cable, supplied with straight to cross conversion cable, 5 m (16.41 ft.) length

Case



CARRYING CASE 9783
Hard trunk type to protect unit during transport

Input modules * Input cords not included. Please purchase them separately.



- ANALOG UNIT 8966**
2 ch, voltage input, 20 MS/s (DC to 5 MHz)
- 4CH ANALOG UNIT U8975**
4 ch, voltage input, 5 MS/s (DC to 2 MHz), input voltage limit: 200 V DC
- 4CH ANALOG UNIT U8978**
4 ch, voltage input, 5 MS/s (DC to 2 MHz), highest sensitivity range 100 mV f.s.
- HIGH RESOLUTION UNIT 8968**
2 ch, voltage input, 1 MS/s (DC to 100 kHz)
- DC/RMS UNIT 8972**
2 ch, voltage input, 1 MS/s (DC to 400 kHz)
RMS rectifier (DC, 30 Hz to 100 kHz)
- HIGH-VOLTAGE UNIT U8974**
2 ch, voltage input, max. 1,000 V DC and 700 V AC
- DIGITAL VOLTMETER UNIT MR8990**
2 ch, high-precision DC voltage, 0.1 μ V resolution, maximum sampling rate 500 times/s
- 3CH CURRENT UNIT U8977**
3 ch, for measuring current using dedicated current sensors, can be directly connected to ME15W (12-pin) connector-type sensors, for use with up to 3 units
- CURRENT UNIT 8971**
2 ch, for measuring current using dedicated current sensors, 2 CONVERSION CABLES 9318 included, for use with up to 4 units
- TEMP UNIT 8967**
2 ch, thermocouple temperature input
- STRAIN UNIT U8969**
2 ch, strain gauge type converter amp
- CONVERSION CABLE L9769**
(for STRAIN UNIT U8969 only, included)
- FREQ UNIT 8970**
2 ch, for measurement of frequency, RPM, pulse, etc.
- CHARGE UNIT U8979**
2 ch, for acceleration measurement, supports charge output, pre-amp output (IEPE type), and voltage output
- LOGIC UNIT 8973**
4 terminals, 16 ch, for use with up to 3 units

Output modules * Output cords not included. Please purchase them separately.



- WAVEFORM GENERATOR UNIT MR8790**
4 ch, \pm 10 V DC output, 1 Hz to 20 kHz sine waveform output
- PULSE GENERATOR UNIT MR8791**
8 ch, 0.1 Hz to 20 kHz pulse output, pattern output
- ARBITRARY WAVEFORM GENERATOR UNIT U8793**
2 ch, 10 mHz to 100kHz FG, -10 V to 15 V output, D/A refresh rate (arbitrary waveform generator mode): 2 MHz

External sampling measurement



- CONNECTION CABLE L9795-01**
SMB terminal to alligator clip, 1.5 m (4.92 ft.)
- CONNECTION CABLE L9795-02**
SMB terminal to BNC terminal, 1.5 m (4.92 ft.)

Logic signal measurement



- LOGIC PROBE 9327**
LOGIC PROBE 9320-01
- 4-channel type, for voltage or contact signal on/off detection
- Not isolated
- Response pulse width: 500 ns or more (9320-01), 100 ns or more (9327)
- Digital input threshold: 1.4 V, 2.5 V, 4.0 V
- Maximum input voltage: 0 V to +50 V DC
- Logic Probe MR9321-01**
- 4 channels, on/off detection of AC/DC voltage
- Isolated
- Response time: rising edge 1 ms max., falling edge 3 ms max.
- Output (high) detection: 170 V to 250 V AC, \pm (70 to 250) V DC (high range) 60 V to 150 V AC, \pm (20 to 150) V DC (low range)
- Output (low) detection: 0 V to 30 V AC, \pm (0 to 43) V DC (high range) 0 V to 10 V AC, \pm (0 to 15) V DC (low range)
- Maximum input voltage: 250 V rms (high range), 150 V rms (low range)

..... U8977 only

INPUT CORD (A) * Voltage is limited to the specifications of the input modules in use.

CONNECTION CORD L9790
Flexible ϕ 4.1 mm (0.16 in.) thin dia. cable allowing for up to 600 V input, 1.8 m (5.91 ft.) length
* The end clip is sold separately

ALLIGATOR CLIP L9790-01
Red/black set attaches to the ends of the cables L9790

GRABBER CLIP 9790-02
When this clip is attached to the end of the L9790, input is limited to CAT II 300 V, red/black set

CONTACT PIN 9790-03
Red/black set attaches to the ends of the cables L9790

INPUT CORD (B) * Voltage is limited to the specifications of the input modules in use

CONNECTION CORD L9198
 ϕ 5.0 mm (0.20 in.) dia., cable allowing for up to 300 V input, 1.7 m (5.58 ft.) length, small alligator clip

CONNECTION CORD L9197
 ϕ 5.0 mm (0.20 in.) dia., cable allowing for up to 600 V input, 1.8 m (5.91 ft.) length, detachable large alligator clips are bundled

GRABBER CLIP L9243
Attaches to the tip of the L9197, red/black set, full length: 185 mm (7.28 in.)

INPUT CORD (C) * The maximum input voltage is derated a based on the input frequency. Please refer to the instruction manual of each probe for details.

10:1 PROBE 9665
Max. rated voltage to ground is same as for input module, 1.5 m (4.92 ft.) length

100:1 PROBE 9666
Max. rated voltage to ground is same as for input module, 1.5 m (4.92 ft.) length

INPUT CORD (D) * Voltage to ground is within this product's specifications. * Separate power source is also required.

DIFFERENTIAL PROBE P9000-01
(Wave form only) for Memory HiCorder, 1 kV AC, DC, frequency band: 100 kHz

DIFFERENTIAL PROBE P9000-02
(Switch between wave form/RMS) for Memory HiCorder, 1 kV AC, DC, frequency band: 100 kHz

AC ADAPTER Z1008
100 V AC to 240 V AC

INPUT CORD (E) * Voltage to ground is within this product's specifications. * Separate power source is also required.

DIFFERENTIAL PROBE 9322
1 kV AC, 2 kV DC, frequency band: 10 MHz

AC ADAPTER 9418-15
100 V AC to 240 V AC

INPUT CORD (F) * For U8974

CONNECTION CABLE L4940
Banana plug, cord length: 1.5 m (4.92 ft.), red and black, 1 each

EXTENSION CABLE L4931
Extend the length of banana plug cables, cable length: 1.5 m (4.92 ft.)

ALLIGATOR CLIP L4935
Attaches to the tip of banana plug cables, CAT IV 600 V, CAT III 1,000 V

BUS BAR CLIP L4936
Attaches to the tip of banana plug cables, CAT III 600 V

MAGNETIC ADAPTER L4937
Attaches to the tip of banana plug cables, CAT III 1,000 V

GRABBER CLIP L9243
Attaches to the tip of banana plug cables, red/black set, full length: 185 mm (7.28 in.), CAT II 1,000 V

INPUT CORD (G) * For MR8990

TEST LEAD L2200
Cable length: 70 cm (2.30 ft.), tips interchangeable with a pin test lead or alligator clip, maximum input voltage: CAT IV 600 V, CAT III 1,000 V

High-precision current measurement * ME15W (12-pin) terminal type * Directly connect to U8977

High-precision pull-through current sensors, observe waveforms from DC to distorted AC
AC/DC CURRENT SENSOR CT6862-05, 1 MHz, 50 A
AC/DC CURRENT SENSOR CT6863-05, 500 kHz, 200 A

Observe waveforms from DC to distorted AC
AC/DC CURRENT PROBE CT6841-05, 1 MHz, 20 A
AC/DC CURRENT PROBE CT6843-05, 500 kHz, 200 A

Observe AC waveforms (cannot observe DC)
CLAMP ON SENSOR 9272-05, 100 kHz, 200 A

High-precision pull-through current sensors, observe waveforms from DC to distorted AC
AC/DC CURRENT SENSOR CT6904, 4 MHz, 500 A

High-precision pull-through current sensors, observe waveforms from DC to distorted AC
AC/DC CURRENT SENSOR CT6875, 2 MHz, 500 A
AC/DC CURRENT SENSOR CT6876, 1.5 MHz, 1,000 A

High-precision pull-through current sensors, observe waveforms from DC to distorted AC
AC/DC CURRENT SENSOR CT6877, 1 MHz, 2,000 A

Observe waveforms from DC to distorted AC
AC/DC CURRENT PROBE CT6844-05, 200 kHz, 500 A
AC/DC CURRENT PROBE CT6845-05, 100 kHz, 500 A
AC/DC CURRENT PROBE CT6846-05, 20 kHz, 1,000 A

General-purpose current measurement * PL14 terminal type

AC/DC AUTO ZERO CURRENT SENSOR CT7731
DC, 1 Hz to 5 kHz, 100 A

AC/DC AUTO ZERO CURRENT SENSOR CT7736
DC, 1 Hz to 5 kHz, 600 A

AC/DC AUTO ZERO CURRENT SENSOR CT7742
DC, 1 Hz to 5 kHz, 2,000 A

AC/DC CURRENT SENSOR CT7631
DC, 1 Hz to 10 kHz, 100 A

AC/DC CURRENT SENSOR CT7636
DC, 1 Hz to 10 kHz, 600 A

AC/DC CURRENT SENSOR CT7642
DC, 1 Hz to 10 kHz, 2,000 A

AC FLEXIBLE CURRENT SENSOR CT7044
 ϕ 100 mm (3.94 in.), 6,000 A

AC FLEXIBLE CURRENT SENSOR CT7045
 ϕ 180 mm (7.09 in.), 6,000 A

AC FLEXIBLE CURRENT SENSOR CT7046
 ϕ 254 mm (10.00 in.), 6,000 A

How to connect to 3CH Current Unit U8977

Current sensor (PL14) + CT9920 → 3CH Current Unit U8977

CONVERSION CABLE CT9920
Convert PL14 terminal to ME15W (12-pin) terminal

How to connect to 3CH Current Unit U8977

High-precision current sensor (ME15W) → 3CH Current Unit U8977

High-precision current sensor (PL23) + CT9900 → 3CH Current Unit U8977

Power supply

SENSOR UNIT CT9555
1ch, with waveform output

SENSOR UNIT CT9556
1ch, with waveform and RMS output

SENSOR UNIT CT9557
4ch, with waveform, total waveform, and total RMS output

CONNECTION CORD L9217
Cord has insulated BNC connectors at both ends, 1.6 m (5.25 ft.) length

How to connect to Current Unit 8971

High-precision current sensor (ME15W) + CT9901 + 9318 → Current Unit 8971

High-precision current sensor (PL23) + 9318 → Current Unit 8971

* 9318 is an accessory of current unit 8971

How to connect to units other than current units (8966, U8975, U8978, 8968, 8972)

High-precision current sensor (ME15W) + CT955x + L9217 → Other unit

High-precision current sensor (PL23) + CT9900 + CT955x + L9217 → Other unit

Conversion cable

CONVERSION CABLE CT9900
Convert PL23 (10-pin) terminal to ME15W (12-pin) terminal

CONVERSION CABLE CT9901
Convert ME15W (12-pin) terminal to PL23 (10-pin) terminal

Leak Current * For commercial power lines, 50/60 Hz

AC LEAKAGE CLAMP METER CM4003
6 mA range (1 μ A resolution) to 200 A range, with WAVE/RMS output, CONNECTION CABLE L9097 (output terminal: BNC, power terminal: USB-C, 1.5 m (4.92 ft.) length) is included

AC ADAPTER Z1013
100 V to 240 V AC

Custom cable * For P9000, inquire with your local Hioki distributor

(1) Bus powered USB cable
(2) USB(A)-Micro B cable
(3) 3-prong cable

High sensitivity, wideband current measurement

CURRENT PROBE CT6710
Frequency characteristics: DC to 50 MHz wideband response, 0.5 A-class up to 30 A rms

CURRENT PROBE CT6711
Frequency characteristics: DC to 120 MHz wideband response, 0.5 A-class up to 30 A rms

CURRENT PROBE CT6700
Frequency characteristics: DC to 50 MHz wideband response, 1 mA-class up to 5 A rms

CURRENT PROBE CT6701
Frequency characteristics: DC to 120 MHz wideband response, 1 mA-class up to 5 A rms

CLAMP ON PROBE 3273-50
Frequency characteristics: DC to 50 MHz wideband response, 10 mA-class up to 30 A rms

CLAMP ON PROBE 3276
Frequency characteristics: DC to 100 MHz wideband response, 10 mA-class up to 30 A rms

CLAMP ON PROBE 3274
Frequency characteristics: DC to 10 MHz wideband response, up to 150 A rms

CLAMP ON PROBE 3275
Frequency characteristics: DC to 2 MHz wideband response, up to 500 A rms

Power supply * Necessary for use the 3270 series current probes

POWER SUPPLY 3272
One sensor can be driven, two sensors can be driven depending on conditions. (Not available for CT6710, CT6711)

POWER SUPPLY 3269
Up to four sensors can be driven. (CT6710 and CT6711 are limited to 2 sensors)

Non-contact voltage measuring

NON-CONTACT AC VOLTAGE PROBE SP3000-01
5 V rms rated, 10 Hz to 100 kHz band width

NON-CONTACT AC VOLTAGE PROBE SP3000
Sold individually

AC VOLTAGE PROBE SP9001
Sold individually

Other options for input

CONNECTION CORD L9217
Cord has insulated BNC connectors at both ends, signal output use, 1.6 m (5.25 ft.) length

CONVERSION ADAPTER 9199
Receiving side banana terminal, output BNC terminal

Temperature sensor

THERMOCOUPLE
*For reference only.
Please purchase locally.

INPUT CABLE (H)

CONNECTION CABLE 9166
BNC-clips, cable length: 1.5 m (4.92 ft.)

Precautions for connecting current sensors and current probes

* The bandwidth of current sensors and current probes is limited by the bandwidth of the current unit to be connected.

* Depending on the combination of current sensors and current probes, physical and space limitations may prevent simultaneous connection. Hioki can assist with special order conversion cables. Please inquire with your local distributor.

* A total of 9 current sensors and current probes can be connected simultaneously to the Memory HiCorder. However, it is limited by the capacity of the current sensor to be connected.

* Three U8977 current units and four 8971 current units can be simultaneously connected to the Memory HiCorder.















* If combining a current sensor or current probe with a sensor power source and using the voltage input analog unit for current measurement, there is no limitation on the number of connections.

* Only the U8977 can use the CT9920 to convert a PL14 connector sensor. The 8971 does not support this combination.



Unit selection guide (17 types)

Unit interchangeability

The following units are compatible with the MR8847A. Some units in the list are also compatible with the MEMORY HiCORDER MR6000, MR8827, MR8740, MR8741, and MR8740-50. Please check the brochure of each product.

	Description model	Measured signal	No. of channels	Fastest sampling	Bandwidth	A/D resolution	DC accuracy	Max. input voltage	Sensitivity (#1)	Max. sensitivity range	Isolation	Additional information
	Analog Unit 8966	Voltage	2 ch	20 MS/s	DC to 5 MHz	12-bit	±0.5% f.s.	400 V DC	0.05 mV	100 mV f.s.	Yes	n/a
	4ch Analog Unit U8975	Voltage (4ch)	4 ch	5 MS/s	DC to 2 MHz	16-bit	±0.1% f.s.	200 V DC	0.125 mV	4 V f.s.	Yes	n/a
	4CH Analog Unit U8978	Voltage (4ch, high resolution)	4 ch	5 MS/s	DC to 2 MHz	16-bit	±0.3% f.s.	40 V DC	3.125 µV	100 mV f.s.	Yes	n/a
	High Resolution Unit 8968	Voltage (high resolution)	2 ch	1 MS/s	DC to 100 kHz	16-bit	±0.3% f.s.	400 V DC	3.125 µV	100 mV f.s.	Yes	with AAF
	DC/RMS Unit 8972	Voltage (DC, RMS)	2 ch	1 MS/s	DC to 400 kHz	12-bit	±0.5% f.s.	400 V DC	0.05 mV	100 mV f.s.	Yes	with RMS
	High Voltage Unit U8974	Voltage (high voltage)	2 ch	1 MS/s	DC to 100 kHz	16-bit	±0.25% f.s.	1000 V DC 700 V AC	0.125 mV	4 V f.s.	Yes	n/a
	Digital Voltmeter Unit MR8990	Voltage (high resolution)	2 ch	2 ms	n/a	24-bit	±0.01% rdg. ±0.0025% f.s.	500 V DC	0.1 µV	100 mV f.s.	Yes	n/a
	3CH Current Unit U8977	Current	3ch	5 MS/s	DC to 2 MHz	16-bit	±0.3% f.s.	Current sensor only	Depends on current sensor		n/a	Max. 3 units
	Current Unit 8971	Current	2 ch	1 MS/s	DC to 100 kHz	12-bit	±0.65% f.s.	Current sensor only	Depends on current sensor		n/a	with RMS Max. 4 units
	Temperature Unit 8967	Temperature	2 ch	1.2 ms	DC	16-bit	See option specifications	Thermocouples only	0.01°C 200°C (392°F) f.s.		Yes	n/a
	Strain Unit U8969	Strain	2 ch	200 kS/s	DC to 20 kHz	16-bit	±0.5% f.s. ±4 µε	Strain only	0.016 µε 400 µε f.s.		Yes	n/a
	Frequency Unit 8970	Frequency	2 ch	200 kS/s	DC to 100 kHz (#2)	16-bit	n/a	400 V DC	0.002 Hz	Depends on mode	Yes	n/a
	Charge Unit U8979	Acceleration	2 ch	200 kS/s	DC to 50 kHz (DC) 1 Hz to 50 kHz (AC)	16-bit	±0.5% f.s. (voltage) ±2.0% f.s. (acceleration)	40 V DC	Depends on acceleration sensor		Yes	Supports TEDS
	Logic Unit 8973	Logic	4 probes (16 ch)	n/a	n/a	n/a	n/a	n/a	n/a	n/a	n/a	Requires 9320-01, 9327 or MR9321-01

(#1) Minimum resolution shows the highest sensitivity resolution. (#2) Minimum pulse width 2 µs

	Description model	No. of channels	Output function	Output voltage range
	Waveform Generator Unit MR8790	4 ch	DC, Sine wave (output frequency range: 0 Hz to 20 kHz)	-10 V to 10 V
	Arbitrary Waveform Generator Unit U8793	2 ch	FG function: sine wave, square wave, pulse wave, triangular wave, ramp wave, and DC Arbitrary waveform generator mode: waveforms measured by MR8847A or generated by SF8000, or CSV waveforms	-10 V to 15 V
	Description Model	No. of channels	Output function	Output terminal
	Pulse Generator Unit MR8791	8 ch	Pulse output: frequency is 0 Hz to 20 kHz Logic output: output voltage level is 0 V to 5 V Open collector output	Connector: D-sub, half-pitch, 50-pin

Note: company names and product names appearing in this brochure are trademarks or registered trademarks of various companies.

HIOKI

HIOKI E. E. CORPORATION

HEADQUARTERS

81 Koizumi,
Ueda, Nagano 386-1192 Japan
<https://www.hioki.com/>



Scan for all regional contact information

DISTRIBUTED BY